

697.1

NOV 8 1929

BOILERS *AND* RADIATORS



The H·B·SMITH CO.



WESTFIELD ^{MASS}
NEW YORK
BOSTON
PHILADELPHIA
CLEVELAND





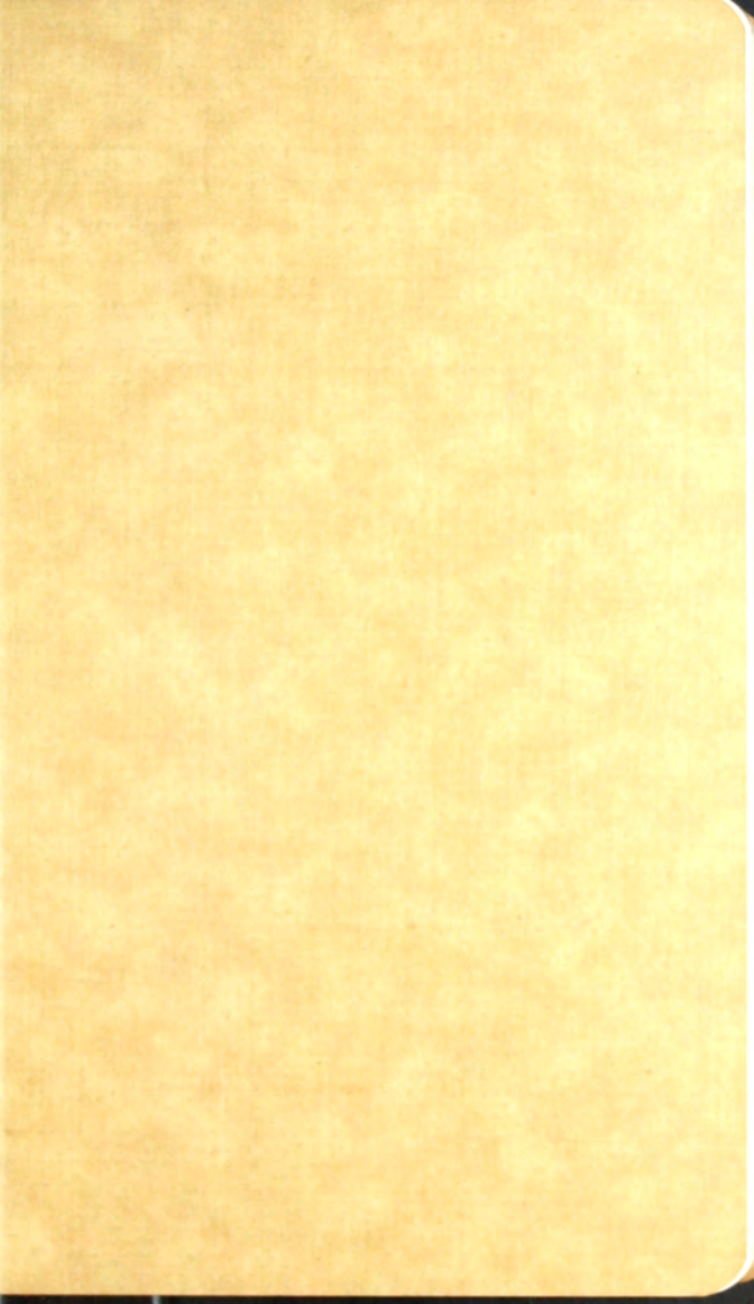

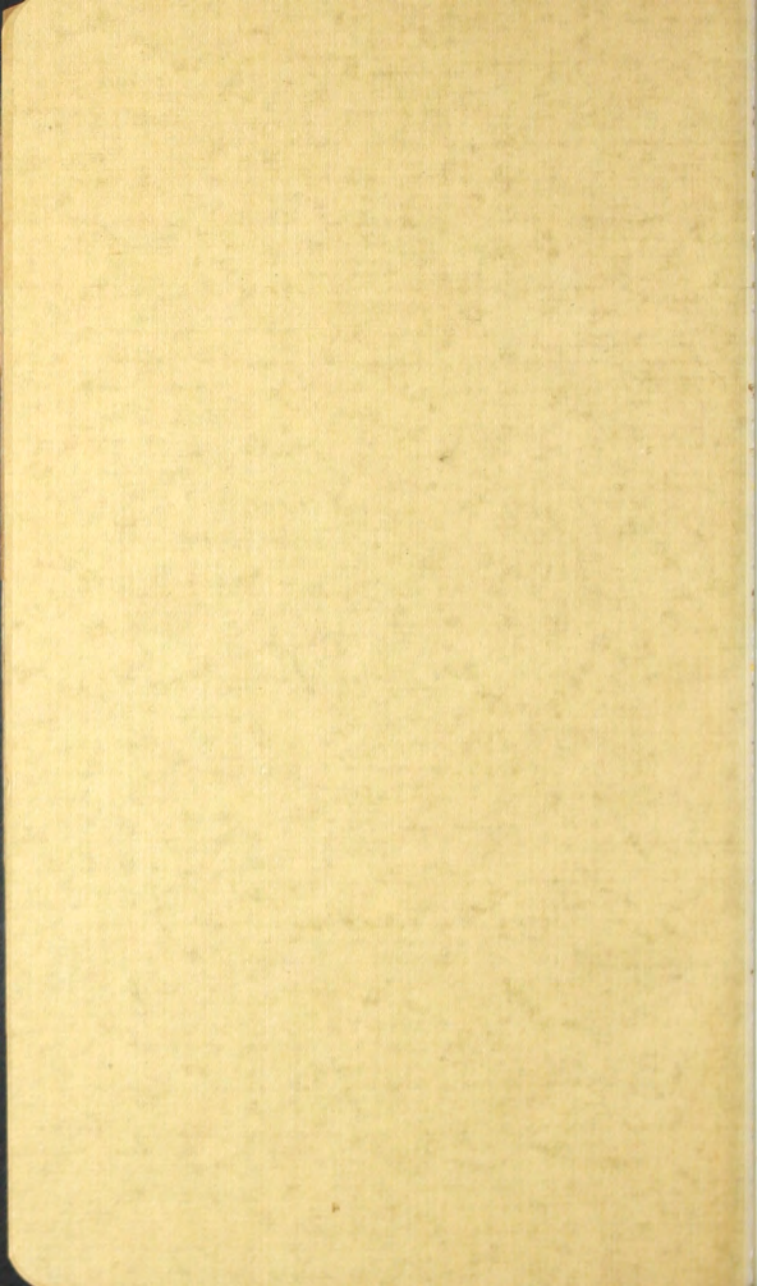

The
H. B. SMITH CO.

WESTFIELD, MASS.

10 East 41st Street
NEW YORK

2209 Chestnut Street
PHILADELPHIA

640 Main St., Cambridge
BOSTON

1108-1110 Webster Ave., S. E.
CLEVELAND

BOILERS USED EXCLUSIVELY FOR LOW PRES-
SURE STEAM AND HOT WATER HEATING
AND HOT WATER SUPPLY

BOILER AND RADIATOR
CATALOG NO. 1444

(Superseding No. 1362-A)

1929

THIS Handbook is published with the purpose of combining within a convenient space much useful information. We believe that such a publication will meet the desires of our customers and serve to further our mutual interests.

That this book will prove of value has been shown by past expressions of appreciation from the trade at large, and a steady demand which quickly exhausted our past editions.

In compiling this book, the old style material no longer carried in stock, has been omitted, and considerable new matter added such as: A new member to our line of Quality Boilers, a complete line of Full Surface Radiation, a new Specialty Section.

It is our hope that this book will prove of much practical use to our friends — The Trade — and promote the continuance of their favor and patronage.

THE H. B. SMITH COMPANY

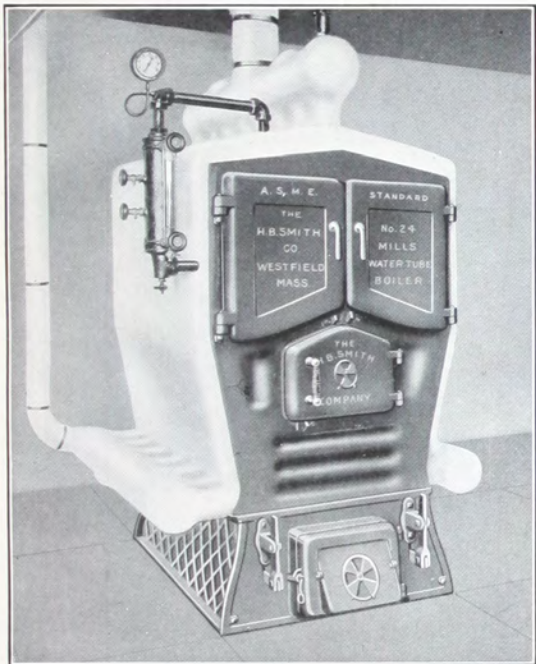

NO. 24 MILLS WATER TUBE BOILER

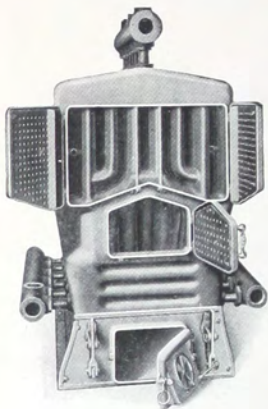

Doors Open



No. 24 Steam Boiler
 Showing Water Tubes
 Arrows indicate fire_travel



Rear View
 No. 24 Steam Boiler

No. 24 Mills Water Tube Boiler

Tested to A.S.M.E. Standard Hydrostatic Pressure
Maximum Allowable Working Pressure—Steam 15 lb., Water 30 lb.

No. of Secs.	Steam Rating Feet	Water Rating Feet	Fire Surface Sq. Ft.	Size of Fire Pot Inches	Area Grate Sq. Ft.	Chimney*		Size of	
						Size Inches	Height Feet	Safety Valve	Water Relief Valve
5	900	1500	75.5	24 x 24	3.33	8 x 12	25	1	3/4
6	1125	1875	91.0	24 x 30	4.17	8 x 12	30	1 1/4	3/4
7	1350	2250	106.5	24 x 36	5.00	12 x 12	25	1 1/4	3/4
8	1575	2600	122.0	24 x 42	5.84	12 x 12	30	1 1/4	1
9	1800	2975	137.5	24 x 48	6.67	12 x 12	35	1 1/2	1
10	2025	3350	153.0	24 x 54	7.50	12 x 16	35	1 1/2	1

*For small sizes of coal or for deep beds of fuel, higher chimneys are required.

DIMENSIONS

No. of Secs.	Total Length Inches	Lgth. at Foundation Inches	Dia. S.P. Opening Inches	Width at Foundation	Width of Sections	Width of Boiler, STEAM	Width of Boiler, WATER	Height of Boiler	Height of Water Line	Height of Ash Pit	Length of Grate Bars	Distance between Center of Grates	Size of Supply Drum Nipples	Size of Return Drum Nipples	Distance from floor to center of Smoke-Pipe
5	48	32	9	29 in.	32 in.	45 in.	48 in.	66 in.	47 in.	12 in.	20 in.	6 in.	1 1/2 in. x 4 1/2 in.	1 1/2 in. x 6 in.	
6	54	38	9												38 in.
7	60	44	10												
8	66	50	10												
9	72	56	12												
10	78	62	12												

SUPPLY DRUM TAPPINGS†

Outside diameter.....6 in.

Tapped for 1 1/2 in. Lock-Nut Nipples

Ends tapped.....2 1/2 in.

RETURN DRUMS

STEAM BOILERS:

Outside diameter.....4 1/2 in.

Tapped for 1 1/2 in. Lock-Nut Nipples

Top and bottom at opposite ends tapped.....2 in.

Ends tapped.....2 1/2 in.

Side tapped.....1 1/4 in.

TAPPINGS ON TOP

Number of Sections	Size of Tappings, in.			
	1 1/4	1 1/2	2	2 1/2
5	1	2	1	
6	1	2	1	
7	1	2	1	
8	1	2	1	1
9	1	1	1	1
10	1	1	1	1

WATER BOILERS:

Outside diameter.....6 in.

Tapped for 1 1/2 in. Lock-Nut Nipples

Top and bottom at opposite ends tapped.....2 in.

Side tapped.....1 1/4 in.

Front ends tapped.....2 1/2 in.

Rear ends tapped.....4 in.

Ash Pit Dimensions, see Page 39
Fire Tools and Steam Trimmings, see Page 55

†TAPPINGS other than those listed are SPECIAL. Order must SPECIFY SIZES.

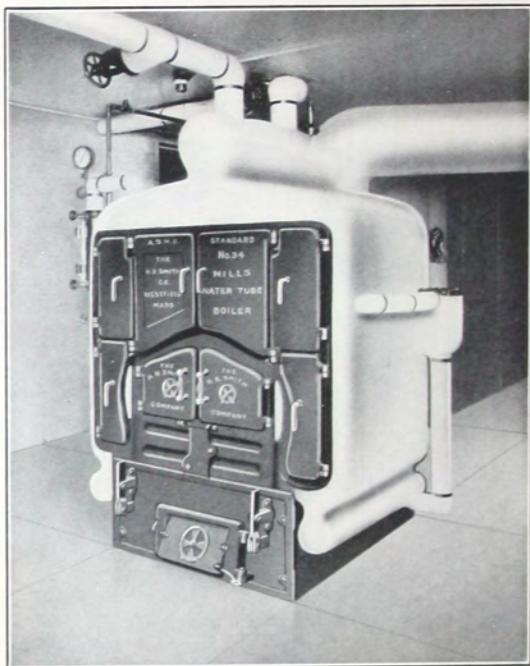

NO. 34 MILLS WATER TUBE BOILER
Showing Domestic Hot Water Supply Attachment

No. 34 Mills Water Tube Boiler

Tested to A.S.M.E. Standard Hydrostatic Pressure
Maximum Allowable Working Pressure—Steam 15 lb., Water 30 lb.

No. of Secs.	Steam Rating Feet	Water Rating Feet	Fire Surface Sq. Ft.	Size of Fire Pot Inches	Area Grate Sq. Ft.	Chimney*		Size of	
						Size Inches	Height Feet	Safety Valve	Water Relief Valve
6	2000	3300	165.0	34 x 30	5.83	12 x 16	30	1½	1
7	2400	3950	192.5	34 x 36	7.00	12 x 16	35	1½	1
8	2800	4625	220.0	34 x 42	8.17	16 x 16	30	1½	1
9	3200	5275	247.5	34 x 48	9.33	16 x 16	35	2	1
10	3600	5950	275.0	34 x 54	10.50	16 x 16	40	2	1½
11	4000	6600	302.5	34 x 60	11.67	16 x 20	30	2	1½
12	4400	7250	330.0	34 x 66	12.83	16 x 20	35	2	1½
13	4800	7925	357.5	34 x 72	14.00	16 x 20	40	2	1½
14	5200	8575	385.0	34 x 78	15.17	16 x 20	45	2½	1½

*For small sizes of coal or for deep beds of fuel, higher chimneys are required.

DIMENSIONS

No. of Secs.	Total Length Inches	Length at Foundation Inches	Size of S.P. Opening Inches	
6	60	37	12 x 12 = 12 Rd.	Width at Foundation.....36
7	66	43	12 x 12 = 12 "	Width of Boiler.....51
8	72	49	12 x 12 = 12 "	Height of Boiler.....78
9	78	55	12½ x 15½ = 14 "	Height of Water Line.....54
10	84	61	12½ x 15½ = 14 "	Height of Ash Pit.....16
11	90	67	12½ x 15½ = 14 "	Length of Grate Bars.....28
12	96	73	12 x 20 = 16 "	Distance between Center of Grates.....6
13	102	79	12 x 20 = 16 "	Size of Supply Drum Nipples.....2 in. x 4½
14	108	85	12 x 20 = 16 "	Size of Return Drum Nipples.....1½ in. x 7
				Distance from floor to Smoke-Pipe Opening.....49

SUPPLY DRUM TAPPINGS†

Outside diameter.....8 in.
Tapped for 2 in. Lock-Nut Nipples
Each end tapped.....2½ in.

TAPPINGS ON TOP

Number of Sections	Size of Tappings, in.				
	2	2½	3	4	5
Ste'm	No. of Tappings				
Wat'r					
6	1		2	1	
7	1		2	1	
8	1		2	1	
9	1	1	1	1	1
10	1	1	1	1	1
11	1	1	1	1	1
12			1	2	1
13			1	2	1
14			1	2	1

RETURN DRUMS

STEAM BOILERS:

Outside diameter.....4½ in.
Tapped for 1½ in. Lock-Nut Nipples
Side tapped.....2 in.
Under side tapped.....1¼ in.
6-10 sections:
Each end tapped.....2½ in.
11-14 sections:
Front ends tapped.....2½ in.
Rear ends tapped.....3 in.

WATER BOILERS:

Outside diameter.....6 in.
Tapped for 1½ in. Lock-Nut Nipples
Under side tapped.....1¼ in.
Front ends tapped.....2½ in.
Rear ends tapped.....4 in.
Side tapped.....2 in.

Ash Pit Dimensions, see Page 39
Fire Tools and Steam Trimmings, see Page 55

†TAPPINGS other than those listed are SPECIAL. Order must SPECIFY SIZES.

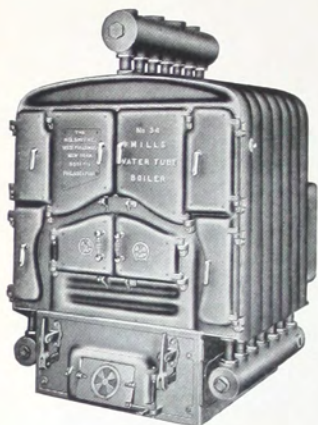

No. 34 Water Boiler

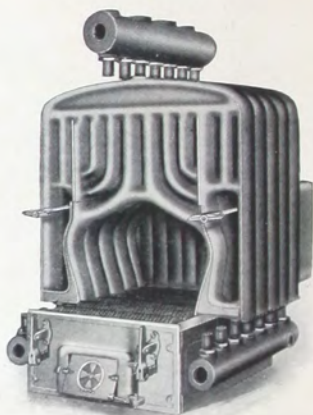

No. 34 Interior

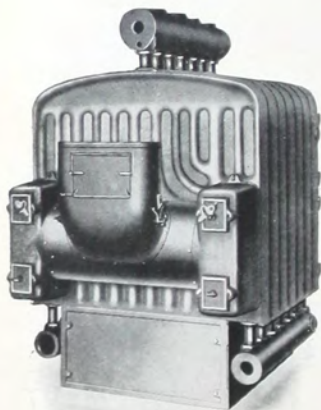

No. 34 Rear View

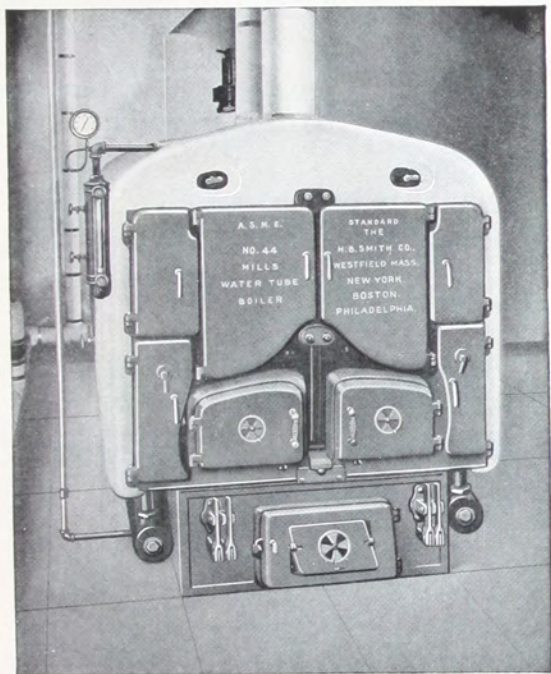

NO. 44 MILLS WATER TUBE BOILER

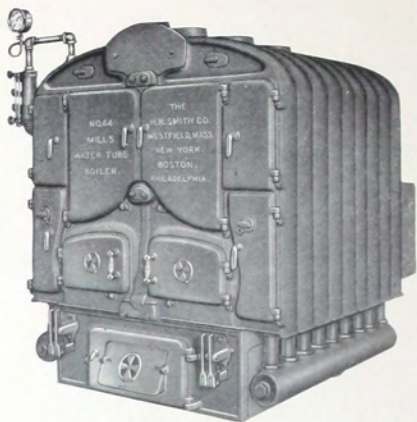

NO. 44 STEAM BOILER

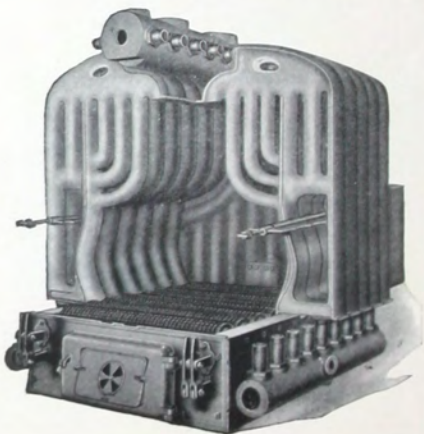

NO. 44 INTERIOR

No. 44 Mills Water Tube Boiler

Tested to A.S.M.E. Standard Hydrostatic Pressure
Maximum Allowable Working Pressure—Steam 15 lb., Water 30 lb.

No. of Secs.	Steam Rating Feet	Water Rating Feet	Fire Surface Sq. Ft.	Size of Fire Pot Inches	Area Grate Sq. Ft.	Chimney*		Size of	
						Size Inches	Height Feet	Safety Valve	Water Relief Valve
7	3600	5950	262	44 x 36	9.50	16 x 16	35	2	1
8	4200	6925	298	44 x 42	11 10	16 x 20	35	2	1 1/4
9	4800	7925	334	44 x 48	12 70	16 x 20	40	2	1 1/4
10	5400	8900	370	44 x 54	14 25	16 x 20	45	2 1/2	1 1/4
11	6000	9900	406	44 x 60	15 80	20 x 20	35	2 1/2	1 1/2
12	6600	10900	442	44 x 66	17 40	20 x 20	40	2 1/2	1 1/2
13	7200	11875	478	44 x 72	19 00	20 x 24	35	2 1/2	1 1/2
14	7800	12875	514	44 x 78	20 60	20 x 24	40	3	1 1/2
15	8400	13850	550	44 x 84	22 20	20 x 24	45	3	1 1/2
16	9000	14850	586	44 x 90	23 75	20 x 24	50	3	1 1/2

*For small sizes of coal or for deep beds of fuel, higher chimneys are required.

DIMENSIONS

No. of Secs.	Total Length Inches	Length at Foundation Inches	Size of S.P. Opening Inches	
7	72	43	13 x 16 3/8 = 15 Rd.	Width at Foundation..... 46 in.
8	78	49	13 x 16 3/8 = 15 "	Width of Boiler..... 64 in.
9	84	55	13 x 16 3/8 = 15 "	Height of Boiler..... 75 in.
10	90	61	13 x 22 3/8 = 18 "	Height of Water Line..... 58 in.
11	96	67	13 x 22 3/8 = 18 "	Height of Ash Pit..... 16 in.
12	102	73	13 x 22 3/8 = 18 "	Length of Grate Bar..... 38 in.
13	108	79	15 x 24 1/2 = 20 "	Size of Supply Drum Nipples..... 2 in. x 4 1/2 in.
14	114	85	15 x 24 1/2 = 20 "	Size of Return Drum Nipples..... 2 in. x 7 in.
15	120	91	15 x 24 1/2 = 20 "	Distance between Center of Grates..... 6 in.
16	126	97	15 x 24 1/2 = 20 "	Distance from floor to Smoke-Pipe Opening..... 50 in.

SUPPLY DRUM TAPPINGS†

Outside diameter..... 10 in.
Tapped for 2 in. Lock-Nut Nipples
Front end tapped..... 2 1/2 in.
Rear end tapped, one 2 1/2 in. and one 2 in.

TAPPINGS ON TOP

Number of Secs.	Size of Tappings, inches					
	2 1/2	3	3 1/2	4	5	6
	Number of Tappings					
7	1	1	.	1	1	.
8	1	1	.	1	1	.
9	.	1	.	1	1	1
10	.	1	.	1	1	1
11	.	1	.	1	1	1
12	.	1	.	.	1	2
13	.	.	1	.	1	2
14	.	.	1	.	1	2
15	.	.	1	.	1	2
16	.	.	1	.	1	2

RETURN DRUMS

STEAM BOILERS:

Outside diameter..... 6 in.
Tapped for 2 in. Lock-Nut Nipples
Front ends tapped..... 2 1/2 in.
Sides tapped..... 2 in.
Under side tapped..... 1 1/4 in.
Rear ends tapped:
7 and 8 sections..... 2 1/2 in.
9 to 16 sections..... 3 in.

WATER BOILERS:

Outside diameter..... 8 in.
Tapped for 2 in. Lock-Nut Nipples
Front ends tapped..... 2 1/2 in.
Rear ends tapped..... 5 in.
Side tapped..... 2 in.

Ash Pit Dimensions, see Page 39
Fire Tools and Steam Trimmings, see Page 55

†TAPPINGS other than those listed are SPECIAL. Order must SPECIFY SIZES.

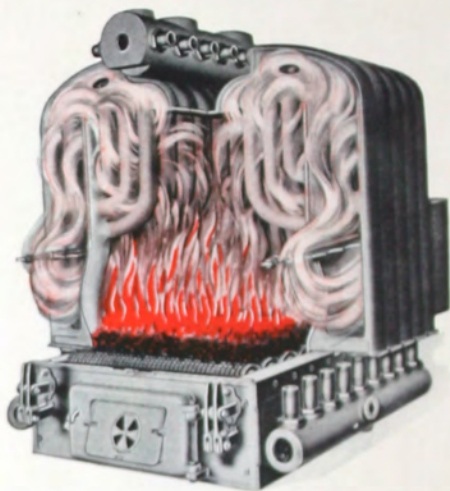

FIRE ACTION ON THE TUBE SURFACE
OF THE MILLS BOILER

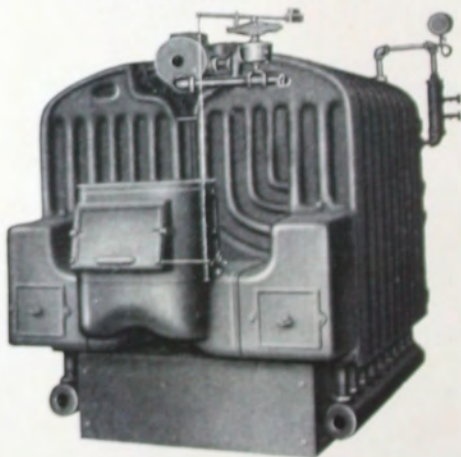

44 REAR VIEW — STEAM

NEW SIXTEEN SMITH



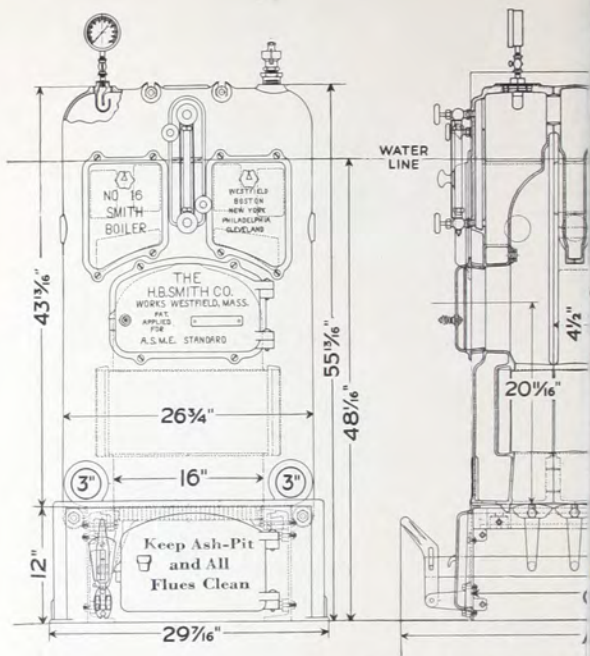

No. 16 S

Tested to A.S.M.E. Standard Hydrostatic Pressure. Maximum DIMENSIONS

Steam Boiler No.	Steam Rating Feet	Water Boiler No.	Water Rating Feet	Heating Surface sq. ft.	Size of Grate Inches	Area of Grate sq. ft.	Fuel Capacity	Recon Chimney Dim. inches
16-S-4	350	16-W-4	600	21.55	16x 9	1.0	The Greatest Fuel Capacity in any Sectional Boiler of the same Grate Area. See Note below *	8x8
16-S-5	500	16-W-5	850	32.00	16x13 1/2	1.5		8x8
16-S-6	650	16-W-6	1100	42.45	16x18	2.0		8x8
16-S-7	800	16-W-7	1350	52.90	16x22 1/2	2.5		8x12
16-S-8	950	16-W-8	1600	63.35	16x27	3.0		8x12
16-S-9	1100	16-W-9	1850	73.80	16x31 1/2	3.5		8x12
16-S-10	1250	16-W-10	2100	84.25	16x36	4.0		8x12

Length of Grate Bars 16"
 Distance between Centers of Grates 4 1/2"

Three 3" Supply Tappings

* Note — Fuel Capacity: Solid fuels vary in weight per cu. ft. from 28 to 55 lbs. has the greatest capacity no matter what size or type
 Computing Size of Boiler: Direct cast-iron radiation (or equivalent) up to

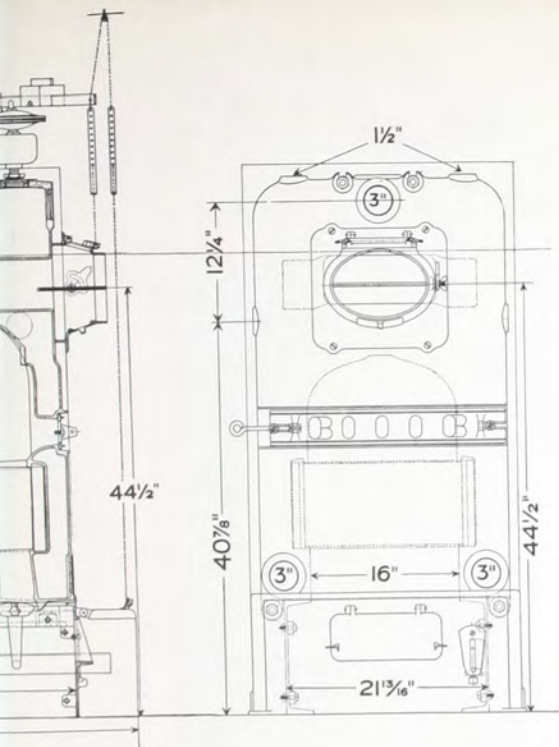

Smith Boiler

Allowable Working Pressure. Steam 15 lbs., Water 30 lbs.

IONS

A

C

Boiler Sizes (Height x Weight)	Boiler No. S or W	No. of Double Sections	No. of 4 1/2" Leg Sections	Total Length of Boiler	Length at Foundation	Steam Safety Valve inches	Water Relief Valve inches
15	16-4	2	0	31 1/4"	18 1/4"	1	1/2
20	16-5	2	1	35 3/4"	22 3/4"	1	3/4
30	16-6	2	2	40 1/4"	27 1/4"	1	3/4
35	16-7	2	3	44 3/4"	31 3/4"	1	3/4
40	16-8	2	4	49 1/4"	36 1/4"	1 1/4	3/4
50	16-9	2	5	53 3/4"	40 3/4"	1 1/4	3/4
65	16-10	2	6	58 1/4"	45 1/4"	1 1/4	1

Diameter of Supply and Return Tappings 3"

Size of Smoke Pipe 9"

our 3" Return Tappings.

ce the fuel capacity in weight depends upon the kind used. The No. 16 Smith used.

o-thirds of No. 16 Smith Boiler Rating may be used satisfactorily.

.. No. 16 .. Smith Boiler

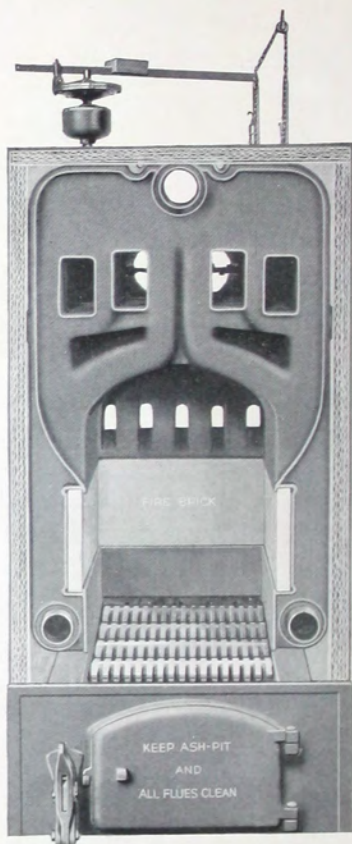

INTERIOR VIEW
(Front Removed)

- Showing: — 1. Large fuel capacity and combustion space
2. Firebrick-Lined Firepot
3. Abundant Heating Surface
4. Air-cell insulation for Jacketed Boilers
5. Auxiliary Air Intake

.. No. 16 ..
Smith Boiler

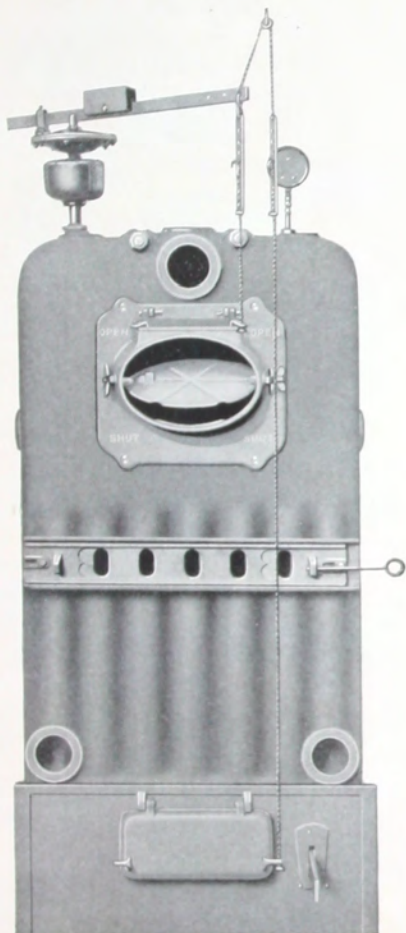

REAR VIEW

Showing all Damper controls including Slide Damper for control of Auxiliary Air

.. No. 16 ..
Smith Boiler

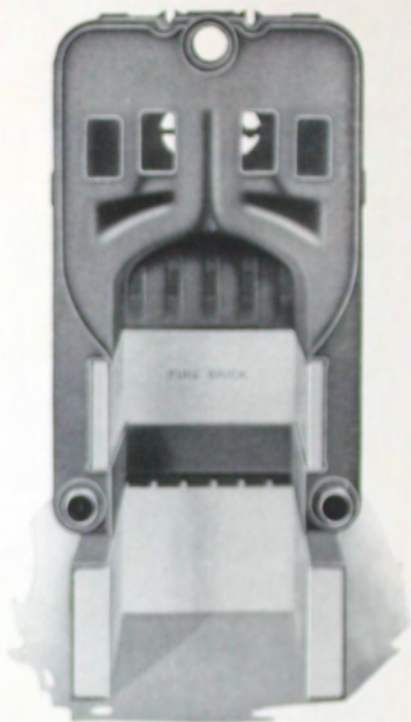

INTERIOR VIEW



SPECIAL
ASH
FRONT

*Showing Ashpit bricked for use in burning oil, accomplished
without sacrifice of combustion space*

No. 27 Smith Smokeless Boiler

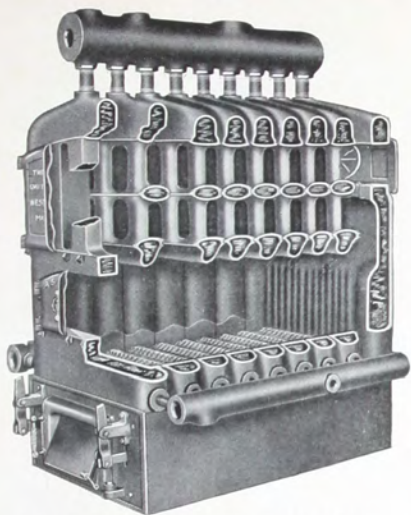

CROSS SECTION Grate Full Size

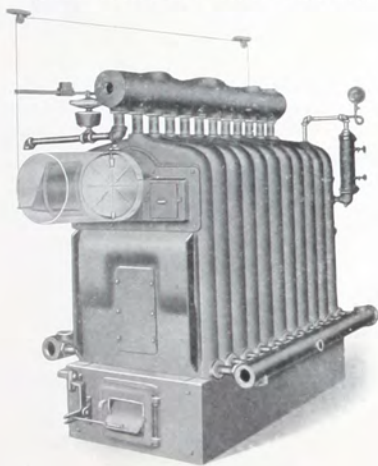

REAR VIEW—STEAM

Showing Control for Air Intake Door (in Ashpit) as on Boilers with Oxygen Torch

No. 27 Smith Smokeless Boiler

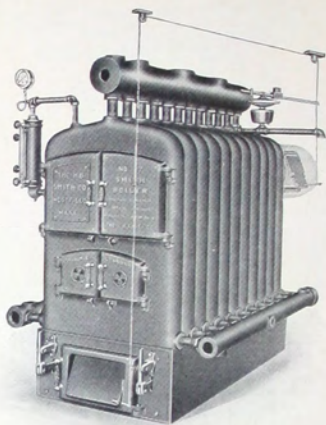

FRONT VIEW—STEAM

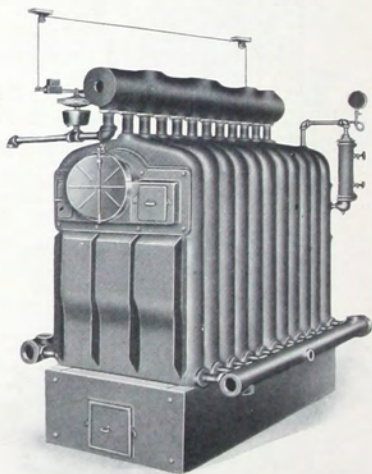

REAR VIEW—STEAM

No. 27 Smith Smokeless Boiler

Tested to A.S.M.E. Standard Hydrostatic Pressure
Maximum Allowable Working Pressure—Steam 15 lb., Water 30 lb.

No. of Secs.	Steam Rating Feet	Water Rating Feet	Fire Surface Sq. Ft.	Size of Fire Pot Inches	Area Grate Sq. Ft.	Chimney*		Size of	
						Size Inches	Height Feet	Safety Valve	Water Relief Valve
5	1200	1975	67.5	27 x 24	4.50	8 x 12	30	1¼	¾
6	1500	2475	81.5	27 x 30	5.63	12 x 12	30	1¼	1
7	1800	2975	95.5	27 x 36	6.75	12 x 12	30	1½	1
8	2100	3475	109.5	27 x 42	7.88	12 x 12	35	1½	1
9	2400	3950	123.5	27 x 48	9.00	12 x 16	35	1½	1
10	2700	4450	137.5	27 x 54	10.13	12 x 16	40	2	1¼
11	3000	4950	151.5	27 x 60	11.25	16 x 16	45	2	1¼
12	3300	5450	172.5	27 x 60	11.25	16 x 16	55	2	1¼
12†	3300	5450	165.5	27 x 66†	12.38	16 x 16	55	2	1¼
13	3600	5950	186.5	27 x 66	12.38	16 x 20	60	2	1¼
13†	3600	5950	179.5	27 x 72†	13.50	16 x 20	60	2	1¼
14	3900	6425	200.5	27 x 66	12.38	16 x 20	65	2	1¼
14†	3900	6425	193.5	27 x 78†	14.63	16 x 20	65	2½	1¼

*For small sizes of coal or for deep beds of fuel, higher chimneys are required.
†Maximum size of fire pot; not shipped as regular.

DIMENSIONS

No. of Secs.	Total Length Inches	L'gth at Foundation Inches	
5	47	32	Width at Foundation.....35 in.
6	53	38	Width of Boiler, STEAM.....56 in.
7	59	44	Width of Boiler, WATER.....59 in.
8	65	50	Height of Boiler.....80 in.
9	71	56	Height of Water Line.....57 in.
10	77	62	Height of Ash Pit.....16 in.
11	83	68	Length of Grate Bar.....27 in.
12	89	74	Distance between Centers of Grate Bars.....6 in.
12†	89	74	Size of Supply Drum Nipples.....2 in. x 6 in.
13	95	80	Size of Return Drum Nipples.....1½ in. x 6 in.
13†	95	80	Distance from Floor to Center of Smoke-Pipe Opening.....55 in.
14	101	86	Size of Smoke-Pipe Opening, Round.....13½ in.
14†	101	86	

SUPPLY DRUM TAPPINGS†

Outside diameter.....8 in.
Each end tapped.....2½ in.
Tapped for 2 in. Lock-Nut Nipples

TAPPINGS ON TOP

Number of Boiler Sections		Size of Tappings in Inches				
Ste'm	Wat'r	2	2½	3	4	5
5	5	1	.	2	1	.
6	6	1	.	2	1	.
7	7	1	.	2	1	.
8	8	1	.	2	1	.
9	9	.	1	1	1	1
10	10	.	1	1	1	1
11	11	.	1	1	1	1
12	12	.	.	1	2	1
13	13	.	.	1	2	1
14	14	.	.	1	2	1

RETURN DRUMS

STEAM BOILERS:

Outside diameter.....4½ in.
Tapped for 1½ in. Lock-Nut Nipples
Top and bottom at opposite ends
tapped.....2 in.
Sides tapped.....2½ in.
Front ends tapped.....2½ in.

Rear ends tapped:

5 to 10 sections.....2½ in.
11 to 14 sections.....3 in.

WATER BOILERS:

Outside diameter.....6 in.
Tapped for 1½ in. Lock-Nut Nipples
Top and bottom opposite ends.....2 in.
Sides tapped.....1¼ in.
Front ends tapped.....2½ in.
Rear ends tapped.....4 in.

Ash Pit Dimensions, see Page 39

Fire Tools and Steam Trimmings, see Page 55

†TAPPINGS other than those listed are SPECIAL. Order must SPECIFY SIZES

No. 27 Smith Smokeless Boiler

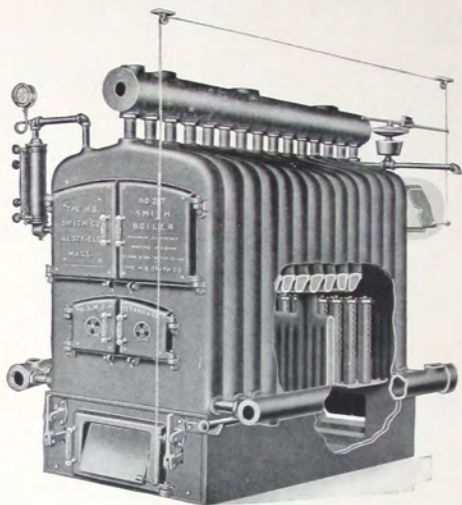

FRONT VIEW — STEAM
Showing oxygen Torch and Controls

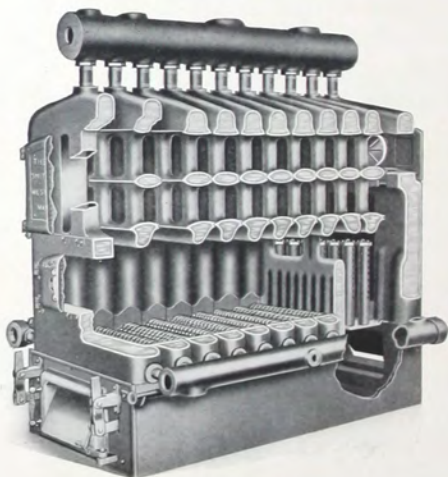

CROSS SECTION
Showing Torch

No. 27 Smith Smokeless Boiler

With Oxygen Torch

Tested to A.S.M.E. Standard Hydrostatic Pressure
Maximum Allowable Working Pressure—Steam 15 lb., Water 30 lb.

No. of Secs.	Steam Rating Feet	Water Rating Feet	Fire Surface Sq. Ft.	Size of Fire Pot Inches	Area Grate Sq. Ft.	Chimney†		Size of	
						Size Inches	Height Feet	Safety Valve	Water Relief Valve
10	2700	4450	144.5	27 x 36	6.75	12 x 16	40	1½	1
11	3000	4950	158.5	27 x 42	7.88	16 x 16	45	1½	1
12	3300	5450	179.5	27 x 48	9.00	16 x 16	55	1½	1
13	3600	5950	193.5	27 x 54	10.13	16 x 20	60	2	1¼
14	3900	6425	207.5	27 x 60	11.25	16 x 20	65	2	1¼
15	4200	6925	221.5	27 x 66	12.38	16 x 20	70	2	1¼

†For small sizes of coal or for deep beds of fuel, higher chimneys are required.

DIMENSIONS

No. of Secs.	Total Length Inches	L'gth at Foundation Inches	Width at Foundation	Width of Boiler, STEAM	Width of Boiler, WATER	Height of Boiler	Height of Water Line	Height of Ash Pit	Length of Grate Bar	Distance between Center of Grates	Size of Supply Drum Nipples	Size of Return Drum Nipples	Distance from Floor to Center of Smoke-Pipe Opening	Size of S.P. Opening 13½ in. Round
10	77	62	35 in.	56 in.	59 in.	80 in.	57 in.	16 in.	27 in.	6 in.	2 in. x 6 in.	1½ in. x 6 in.		
11	83	68												
12	89	74												
13	95	80												
14	101	86												
15	107	92												

SUPPLY DRUM TAPPINGS*

Outside diameter 8 in.
Each end tapped 2½ in.
Tapped for 2 in. Lock-Nut Nipples

NUMBER OF TAPPINGS

Number of Boiler Sections		Size of Tappings in Inches			
Ste'm	Wat'r	2½	3	4	5
10	11	1	1	1	1
11	12	1	1	1	1
12	13	1	1	2	1
13	14	1	1	2	1
14	15	1	1	2	1
15		1	1	2	1

RETURN DRUMS

STEAM BOILERS:

Outside diameter 4½ in.
Tapped for 1½ in. Lock-Nut Nipples
Top and bottom at opposite ends
tapped 2 in.
Side tapped 1¼ in.
Front ends tapped 2½ in.
Rear ends tapped:
10 section 2½ in.
11-16 sections 3 in.

WATER BOILERS:

Outside diameter 6 in.
Tapped for 1½ in. Lock-Nut Nipples
Top and bottom opp. ends . . . 2 in.
Side tapped 1¼ in.
Front ends tapped 2½ in.
Rear ends tapped 4 in.

Ash Pit Dimensions, see Page 39

Fire Tools and Steam Trimmings, see Page 55

*TAPPINGS other than those listed are SPECIAL. Order must SPECIFY SIZES.

No. 36 Smith Smokeless Boiler

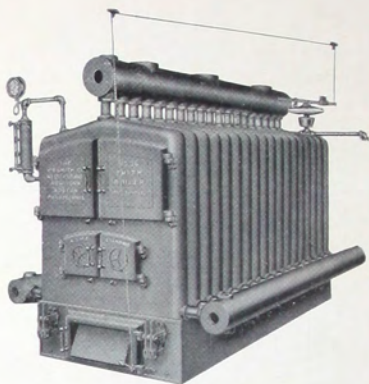

FRONT VIEW

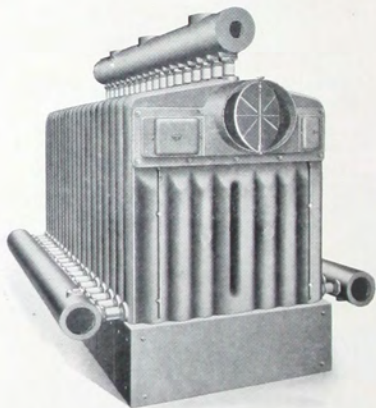

REAR VIEW
Grate full Size

Openings for coils no longer furnished unless specially ordered

No. 36 Smith Smokeless Boiler

Tested to A.S.M.E. Standard Hydrostatic Pressure
Maximum Allowable Working Pressure—Steam 15 lb., Water 30 lb.

No. of Secs.	Steam Rating Feet	Water Rating Feet	Fire Surface Sq. Ft.	Size of Fire Pot Inches	Area Grate Sq. Ft.	Chimney*		Size of	
						Size Inches	Height Feet	Safety Valve	Water Relief Valve
7	2300	3800	133.5	36 x 36	9.00	16 x 16	30	1½	1
8	2800	4625	153.	36 x 42	10.50	16 x 16	35	2	1¼
9	3300	5450	172.5	36 x 48	12.00	16 x 16	40	2	1¼
10	3800	6275	192.	36 x 54	13.50	16 x 20	45	2	1¼
11	4300	7100	211.5	36 x 60	15.00	16 x 20	55	2½	1¼
12	4800	7925	241.	36 x 60	15.00	16 x 20	60	2½	1¼
12†	4800	7925	231.	36 x 66†	16.50	16 x 20	60	2½	1½
13	5300	8750	260.5	36 x 66	16.50	20 x 20	65	2½	1½
13†	5300	8750	250.5	36 x 72†	18.00	20 x 20	65	2½	1½
14	5800	9575	280.	36 x 66	16.50	20 x 20	70	2½	1½
14†	5800	9575	270.	36 x 78†	19.50	20 x 20	70	2½	1½
15	6300	10400	299.5	36 x 72	18.00	20 x 20	75	2½	1½
15†	6300	10400	289.5	36 x 84†	21.00	20 x 20	75	3	1½

*For small sizes of coal or for deep beds of fuel, higher chimneys are required.

†Maximum size of fire pot; not shipped as regular.

DIMENSIONS

No. of Secs.	Total Length Inches	L'gth at Foundation Inches		
7	56	44	Width at Foundation	48¼ in.
8	62	50	Width of Boiler, STEAM	72 in.
9	68	56	Width of Boiler, WATER	76 in.
10	74	62	Height of Boiler	83 in.
11	80	68	Height of Water Line	59 in.
12	86	74	Height of Ash Pit	16 in.
12†	86	74	Length of Grate Bars	35½ in.
13	92	80	Distance between Center of Grates	6 in.
13†	92	80	Size of Supply Drum Nipples	2½ x 6 in.
14	98	86	Size of Return Drum Nipples	2 x 6 in.
14†	98	86	Distance from Floor to Center of Smoke-Pipe Opening	59 in.
15	104	92	Size of S.P. Opening 15½ in. Round	
15†	104	92		

SUPPLY DRUM TAPPINGS†

Outside diameter, 10 in.
Tapped for 2½ in. Lock-Nut Nipples

Each end tapped, 2½ in.

TAPPINGS ON TOP

Number of Sections	Size of Tappings, in.						
	2½	3	3½	4	5	6	
Ste'm	Wat'r	No. of Tappings					
	7	1	.	.	3	.	.
7	8	1	.	.	3	.	.
8	9	1	.	.	3	.	.
9	10	1	.	.	2	1	.
10	11	.	1	.	2	1	.
11	12	.	1	.	2	1	1
12	13	.	1	.	2	1	1
13	14	.	.	1	.	2	1
14	15	.	.	1	.	.	3
15		.	.	1	.	.	3

RETURN DRUMS

STEAM BOILERS:

Outside diameter, 6 in.
Tapped for 2 in. Lock-Nut Nipples
Top and bottom at opp. ends tapped, 2 in.
Front ends tapped, 2½ in.
Side tapped, 1¼ in.

Rear ends tapped:

7 and 8 sections, 2½ in.
9 to 15 sections, 3 in.

WATER BOILERS:

Outside diameter, 8 in.
Tapped for 2 in. Lock-Nut Nipples
Top and bottom, 2 in.
Front ends tapped, 2½ in.
Rear ends tapped, 5 in.

Ash Pit Dimensions, see Page 39

Fire Tools and Steam Trimmings, see Page 55

†TAPPINGS other than those listed are SPECIAL. Order must SPECIFY SIZES

No. 36 Smith Smokeless Boiler

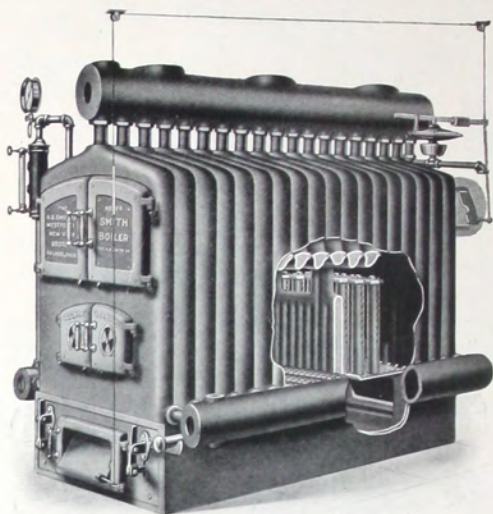

Showing Oxygen Torch and Controls

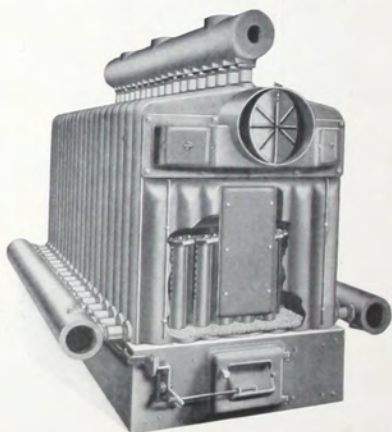

REAR VIEW

Showing Control for Air Intake Door (in the Ashpit)
on Boilers with Oxygen Torch

No. 36 Smith Smokeless Boiler

With Oxygen Torch

Tested to A.S.M.E. Standard Hydrostatic Pressure
Maximum Allowable Working Pressure—Steam 15 lb., Water 30 lb.

No. of Secs.	Steam Rating Feet	Water Rating Feet	Fire Surface Sq. Ft.	Size of Fire Pot Inches	Area Grate Sq. Ft.	Chimney*		Size of	
						Size Inches	Height Feet	Safety Valve	Water Relief Valve
11	4300	7100	221.5	36 x 42	10.50	16 x 20	55	2	1 1/4
12	4800	7925	241.	36 x 48	12.00	16 x 20	60	2	1 1/4
13	5300	8750	260.5	36 x 54	13.50	20 x 20	65	2	1 1/4
14	5800	9575	280.	36 x 60	15.00	20 x 20	70	2 1/2	1 1/4
15	6300	10400	299.5	36 x 66	16.50	20 x 20	75	2 1/2	1 1/2

*For small sizes of coal or for deep beds of fuel, higher chimneys are required.

DIMENSIONS

No. of Secs.	Total Length Inches	L'gth at Foundation Inches	Width at Foundation	Width of Boiler, STEAM	Width of Boiler, WATER	Height of Boiler	Height of Water Line	Height of Ash Pit	Length of Grate Bar	Distance between Center of Grates	Size of Supply Drum Nipples	Size of Return Drum Nipples	Distance from Floor to Center of Smoke-Pipe Opening	Size of S.P. Opening 15 1/2 in. Round
11	80	68	48 1/4 in.	72 in.	76 in.	83 in.	59 in.	16 in.	35 5/8 in.	6 in.	2 1/2 x 6 in.	2 x 6 in.	59 in.	
12	86	74												
13	92	80												
14	98	86												
15	104	94												

SUPPLY DRUM TAPPINGS†

Outside diameter 10 in.
Tapped for 2 1/2 in. Lock-Nut Nipples
Each end tapped 2 1/2 in.

TAPPINGS ON TOP

Number of Sections	Size of Tappings, in.	No. of Tappings				
		3	3 1/2	4	5	6
Ste'm	Wat'r					
11	11	1	.	2	1	.
12	12	1	.	2	.	1
12	13	1	.	.	2	1
13	14	.	1	.	2	1
14	15	.	1	.	.	3
15	..	.	1	.	.	3

RETURN DRUMS

STEAM BOILERS:

Outside diameter 6 in.
Tapped for 2 in. Lock-Nut Nipples
Top and bottom at opposite ends tapped 2 in.
Front ends tapped 2 1/2 in.
Side tapped 1 1/4 in.
Rear ends tapped 3 in.

WATER BOILERS:

Outside diameter 8 in.
Tapped for 2 in. Lock-Nut Nipples
Front ends tapped 2 1/2 in.
Rear ends tapped 5 in.
Top and bottom tapped 2 in.

Ash Pit Dimensions, see Page 39

Fire Tools and Steam Trimmings, see Page 55

†TAPPINGS other than those listed are SPECIAL. Order must SPECIFY SIZES.

No. 36 Smith Smokeless Boiler

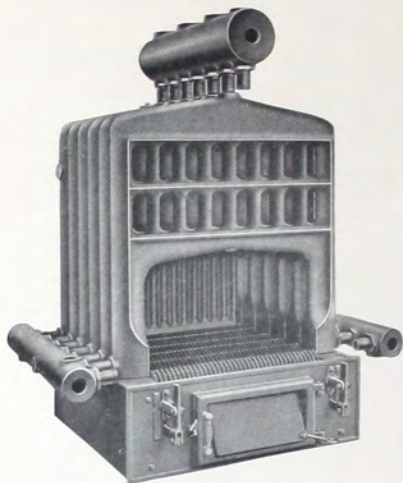

FRONT VIEW
Showing Enormous Fire Surface

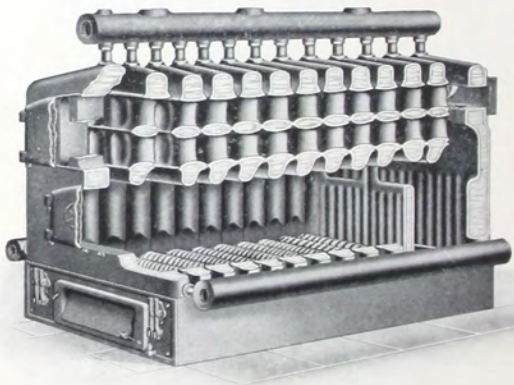

CROSS SECTION
Showing Flue Travel

No. 42 Smith Smokeless Boiler

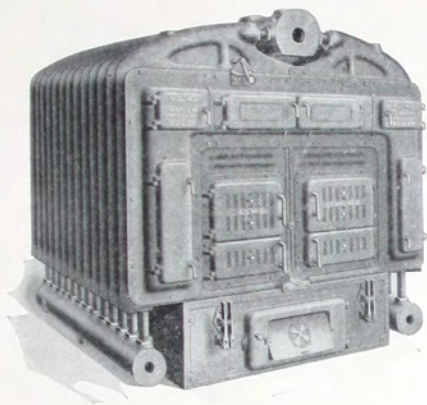

FRONT VIEW

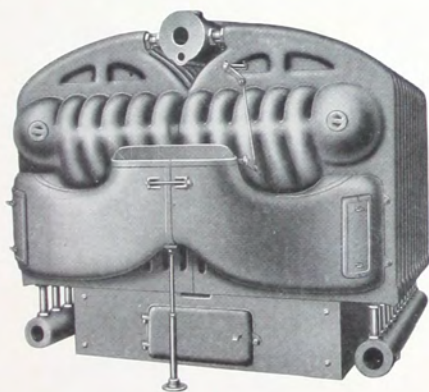

REAR VIEW
Grate Reduced

No. 42 Smith Smokeless Boiler

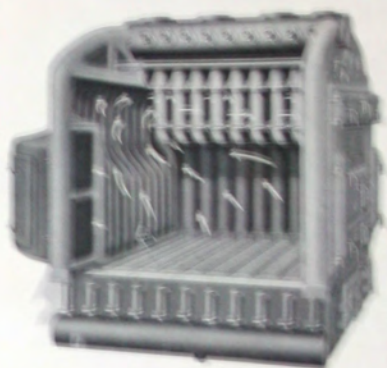

INTERIOR
Grate Full Size

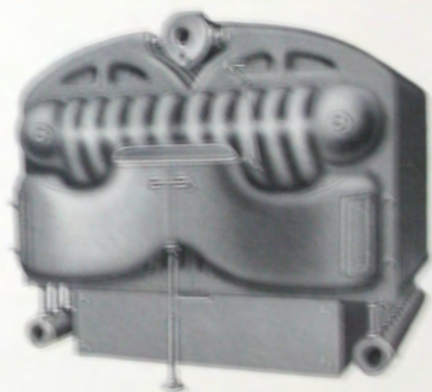

REAR VIEW
Grate Full Size

No. 42 Smith Smokeless Boiler

Tested to A.S.M.E. Standard Hydrostatic Pressure
Maximum Allowable Working Pressure—Steam 15 lb., Water 30 lb.

No. of Sections	Fire Surface Sq. Ft.	Size of Fire Pot Inches	Area Grate Sq. Ft.	Chimney*		Size of	
				Size Inches	Height Feet	Safety Valve	Water Relief Valve
7	180.	42 x 30	8.75	16 x 20	35	1½	1
8	205.	42 x 36	10.50	16 x 20	35	2	1¼
9	230.	42 x 42	12.25	20 x 20	40	2	1¼
10	255.5	42 x 48	14.00	20 x 20	45	2	1¼
11	279.5	42 x 54	15.75	20 x 24	50	2½	1¼
12	305.	42 x 60	17.50	20 x 24	60	2½	1½
13	330.	42 x 66	19.25	20 x 24	70	3	1½
14	355.	42 x 72	21.00	24 x 24	70	3	1½

*For small sizes of coal or for deep beds of fuel, higher chimneys are required.

DIMENSIONS

No. of Secs.	Total Length Inches	L'gth at Foundation Inches	Width at Foundation	Width of Boiler	Height of Boiler	Height of Water Line	Height of Ash Pit	Length of Grate Bars	Distance between Centers of Grates	App. Width of Air Space in Grate	Prop. of Air Space to Grate Surface	Size of Smoke-Pipe Opening	Equals in area 22 in. Round	in circumference 24 in. Round	Distance from Floor to S.P. Opening
7	76¼	46¾	50 in.	68¾ in.	76¼ in.	60 in.	16 in.	41¾ in.	6 in.	½ in.	52%	16¾ x 27¾ in.			57 in.
8	82¼	52¾													
9	88¼	58¾													
10	94¼	64¾													
11	100¼	70¾													
12	106¼	76¾													
13	112¼	82¾													
14	118¼	88¾													

SUPPLY DRUM TAPPINGS

Outside diameter 10 in.

Tapped for 2 in. Lock-Nut Nipples

Front end tapped 2½ in.

Rear ends tapped one 2 in., and one 2½ in.

TAPPINGS ON TOP

No. of Secs.	Size of Tappings, inches					
	2½	3	3½	4	5	6
No. of Tappings						
7	1	1	.	1	1	.
8	1	1	.	1	1	.
9	.	1	.	1	1	1
10	.	1	.	1	1	1
11	.	1	.	1	1	1
12	.	1	.	.	1	2
13	.	.	1	.	1	2
14	.	.	1	.	1	2

RETURN DRUM TAPPINGS

STEAM BOILERS:

Outside diameter 6 in.

Tapped for 2 in. Lock-Nut Nipples

Front ends tapped 2½ in.

Sides tapped 2 in.

Undersides tapped 1¼ in.

Rear ends tapped:

7-8 sections 2½ in.

9-16 sections 3 in.

WATER BOILERS:

Outside diameter 8 in.

Front ends tapped 2½ in.

Rear ends tapped 5 in.

Side drip tapped 2 in.

Ash Pit Dimensions, see Page 39

Fire Tools and Steam Trimmings, see Page 55

†TAPPINGS other than those listed are SPECIAL. Order must SPECIFY SIZES.

No. 42 Smith Smokeless Boiler

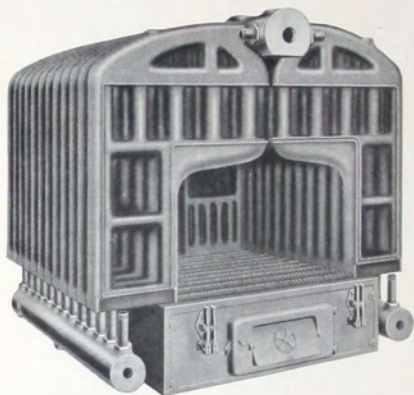

FRONT VIEW

Showing Enormous Amount of Fire Surface

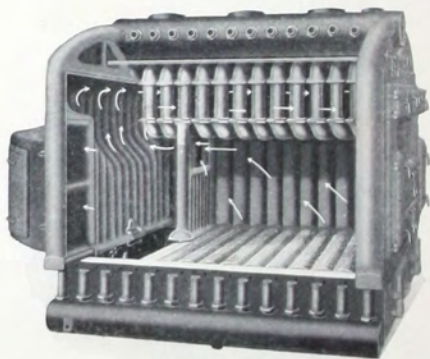

CROSS SECTION

Showing Flue Travel

No. 42 Smith Smokeless Boiler

Tested to A.S.M.E. Standard Hydrostatic Pressure
Maximum Allowable Working Pressure—Steam 15 lb., Water 30 lb.

No. of Sections	Fire Surface Sq. Ft.	Size of Fire Pot Inches	Area Grate Sq. Ft.	Chimney*		Size of	
				Size Inches	Height Feet	Safety Valve	Water Relief Valve
10	269.5	42 x 30	8.75	20 x 20	40	1½	1
11	293.5	42 x 36	10.50	20 x 20	45	2	1¼
12	318.5	42 x 42	12.25	20 x 24	50	2	1¼
13	344.	42 x 48	14.00	20 x 24	60	2	1¼
14	369.	42 x 54	15.75	24 x 24	70	2½	1¼
15	393.	42 x 60	17.50	24 x 24	75	2½	1½
16	418.5	42 x 60	17.50	24 x 24	85	2½	1½
17	443.5	42 x 66	19.25	24 x 24	90	3	1½

*For small sizes of coal or for deep beds of fuel, higher chimneys are required.

DIMENSIONS

No. of Secs.	Total Length Inches	L'gth at Foundation Inches	Width at Foundation	Width of Boiler	Height of Boiler	Height of Water Line	Height of Ash Pit	Length of Grate Bars	Distance between Centers of Grates	Approximate width of Air Space in Grate	Proportion of Air Space to Grate Surface	Size of Smoke-Pipe Opening	Equals in Area 22 in. Round in circumference 24 in. Round	Distance from Floor to S.P. Opening
10	94¼	64½	50 in.	68¾ in.	76¾ in.	60 in.	16 in.	41¾ in.	6 in.	½ in.	52%	16¾ x 27¾ in.		
11	100¼	70½												
12	106¼	76½												
13	112¼	82½												
14	118¼	88½												
15	124¼	94½												
16	130¼	100½												
17	136¼	106½												

SUPPLY DRUM TAPPINGS†

Outside diameter 10 in.
Tapped for 2 in. Lock-Nut Nipple.
Front end tapped 2½ in.
Rear ends tapped one 2 in., and one 2½ in.

RETURN DRUM TAPPINGS

STEAM BOILERS:
Outside diameter 6 in.
Tapped for 2 in. Lock-Nut Nipples
Front ends tapped 2½ in.
Sides tapped 2 in.
Undersides tapped 1¼ in.
Rear ends tapped:
7-8 sections 2½ in.
9-16 sections 3 in.

TAPPINGS ON TOP

No. of Secs.	Size of Tappings, inches					No. of Tappings
	3	3½	4	5	6	
10	1	.	1	1	1	1
11	1	.	1	1	1	1
12	1	.	.	1	1	2
13	.	1	.	1	1	2
14	.	1	.	1	1	2
15	.	1	.	1	1	2
16	.	1	.	1	1	2

WATER BOILERS:

Outside diameter 8 in.
Front ends tapped 2½ in.
Rear ends tapped 5 in.
Side drip tapped 2 in.

Ash Pit Dimensions, see Page 39
Fire Tools and Steam Trimmings, see Page 55

†TAPPINGS other than those listed are SPECIAL. Order must SPECIFY SIZES.

No. 60 Smith Smokeless Boiler

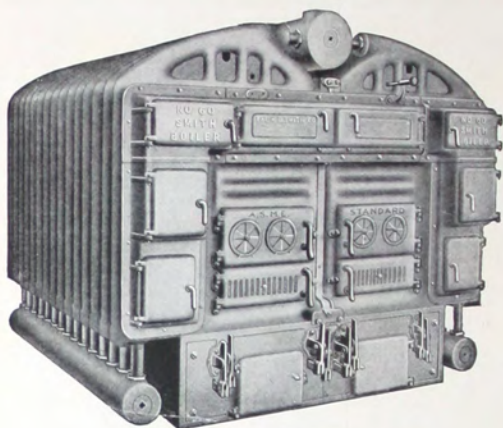

FRONT VIEW

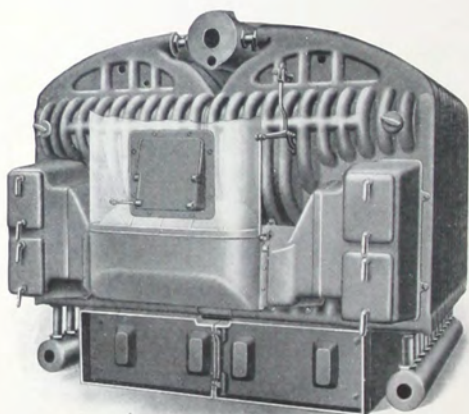

REAR VIEW
Grate Full Size

No. 60 Smith Smokeless Boiler

Tested to A.S.M.E. Standard Hydrostatic Pressure
Maximum Allowable Working Pressure—Steam 15 lb., Water 30 lb.

No. of Secs.	Steam Rating Feet	Water Rating Feet	Fire Surface Sq. Ft.	Size of Fire Pot Inches	Area Grate Sq. Ft.	Chimney*		Size of	
						Size Inches	Height Feet	Safety Valve	Water Relief Valve
10	8400	13850	413	60 x 48	20.00	20 x 24	40	3	1½
11	9600	15850	448	60 x 54	22.50	20 x 24	50	3	1½
12	10800	17800	488	60 x 60	25.00	24 x 24	60	3½	1½
13	12000	19800	527	60 x 66	27.50	24 x 24	70	3½	2
14	13200	21800	566	60 x 72	30.00	24 x 28	75	4	2
15	14400	23750	602	60 x 78	32.50	28 x 28	85	4	2
16	15600	25750	641	60 x 84	35.00	28 x 28	95	4½	2
17†	16800	27700	704	60 x 78†	32.50	28 x 28	105	4½	2
18†	18000	29700	743	60 x 84†	35.00	28 x 32	110	4½	2
19†	19200	31700	783	60 x 84†	35.00	28 x 32	115	4½	2
20†	20400	33650	822	60 x 84†	35.00	28 x 32	120	4½	2

*For small sizes of coal or for deep beds of fuel, higher chimneys are required.
†Boilers shipped with Grate Reduced as indicated unless otherwise specified.

DIMENSIONS

No. of Secs.	Total Length Inches	L'gth of Foundation Inches	
10	98	61	Width at Foundation..... 72 in.
11	104	67	Width of Boiler..... 98 in.
12	110	73	Height of Boiler..... 87 in.
13	116	79	Height of Water Line..... 69 in.
14	122	85	Height of Ash Pit..... 18 in.
15	128	91	Length of Grate Bars (double)..... 60 in.
16	134	97	Distance between Centers of Grates..... 6 in.
17	140	103	Size of Supply Drum Nipples..... 2 x 4½ in.
18	146	109	Size of Return Drum Nipples..... 2 x 9 in.
19	152	115	Distance from Floor to Smoke-Pipe Opening..... 41 in.
20	158	121	Size of Smoke-Pipe Opening: 16 x 37 oval equals in area 26 round, in circumference 29½ round

TAPPINGS ON TOP OF SUPPLY DRUM

Number of Sections	Size of Tappings, in.	
	5	8
	No. of Tappings	
10	2	2
11	2	2
12	2	2
13	2	2
14	2	3
15	2	3
16	2	3
17	2	3
18	2	3
19	2	3
20	2	3

REGULAR TAPPINGS†

Supply Drum

Outside diameter..... 12 in.
Tapped for 2 in. Lock-Nut Nipples.
Front end tapped..... 2 in.
Rear end tapped one 4 in. and one 2 inches.

Return Drums

Outside diameter..... 8 in.
Tapped for 2 in. Lock-Nut Nipples
Front ends tapped..... 2½ in.
Rear ends tapped..... 5 in.
Side drip tapped..... 2 in.

Ash Pit Dimensions, see Page 39
Fire Tools and Steam Trimmings, see Page 55

†TAPPINGS other than those listed are SPECIAL. Order must SPECIFY SIZES.

No. 60 Smith Smokeless Boiler

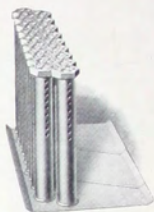

OXYGEN TORCH

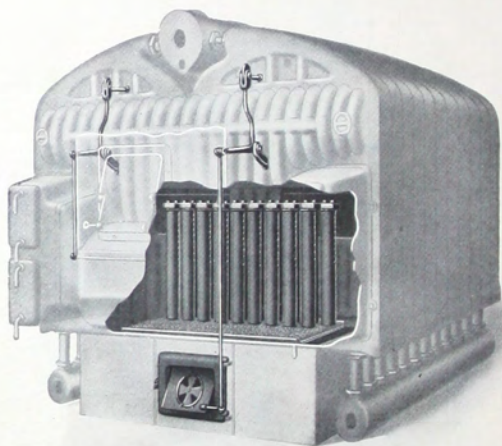

REAR VIEW

No. 60 Smith Smokeless Boiler

With Oxygen Torch

Tested to A.S.M.E. Standard Hydrostatic Pressure
Maximum Allowable Working Pressure—Steam 15 lb., Water 30 lb.

No. of Secs.	Steam Rating Feet	Water Rating Feet	Fire Surface Sq. Ft.	Size of Fire Pot Inches	Area Grate Sq. Ft.	Chimney*		Size of	
						Size Inches	Height Feet	Safety Valve	Water Relief Valve
12	10800	17800	512	60 x 42	17.5	24 x 24	60	2½	1½
13	12000	19800	551	60 x 48	20.0	24 x 24	70	3	1½
14	13200	21800	590	60 x 54	22.5	24 x 28	75	3	1½
15	14400	23750	629	60 x 60	25.0	28 x 28	85	3½	1½
16	15600	25750	669	60 x 66	27.5	28 x 28	95	3½	2
17	16800	27700	704	60 x 66	27.5	28 x 28	105	3½	2
18	18000	29700	743	60 x 72	30.0	28 x 32	110	4	2
19	19200	31700	783	60 x 78	32.5	28 x 32	115	4	2
20	20400	33650	822	60 x 78	32.5	28 x 32	120	4	2

*For small sizes of coal or for deep beds of fuel, higher chimneys are required.

DIMENSIONS

No. of Secs.	Total Length Inches	L'gth at Foundation Inches	Width at Foundation	Width of Boiler	Height of Boiler	Height of Water Line	Height of Ash Pit	Length of Grate Bars (double)	Distance between Center of Grates	Size of Supply Drum Nipples	Size of Return Drum Nipples	Distance from Floor to Smoke-Pipe Opening	Size of Smoke-Pipe Opening, inches:
12	110	73	72 in.	98 in.	87 in.	69 in.	18 in.	60 in.	6 in.	2 x 4½ in.	2 x 9 in.	41 in.	16 x 37 oval equals in area 26 round, in circumference 29½ round
13	116	79											
14	122	85											
15	128	91											
16	134	97											
17	140	103											
18	146	109											
19	152	115											
20	158	121											

TAPPINGS ON TOP OF SUPPLY DRUM

Number of Sections	Size of Tappings, in.	
	5	8
	Number of Tappings	
12	2	2
13	2	2
14	2	3
15	2	3
16	2	3
17	2	3
18	2	3
19	2	3
20	2	3

REGULAR TAPPINGS† Supply Drum

Outside diameter 12 in.
Tapped for 2 in. Lock-Nut Nipples

Front end tapped 2 in.
Rear end tapped one 4 in. and one 2 in.

Return Drums

Outside diameter 8 in.
Tapped for 2 in. Lock-Nut Nipples

Front ends tapped 2½ in.
Rear ends tapped 5 in.
Side drip tapped 2 in.

Ash Pit Dimensions, see Page 39
Fire Tools and Steam Trimmings, see Page 55

†TAPPINGS other than those listed are SPECIAL. Order must SPECIFY SIZES.

No. 60 Smith Smokeless Boiler

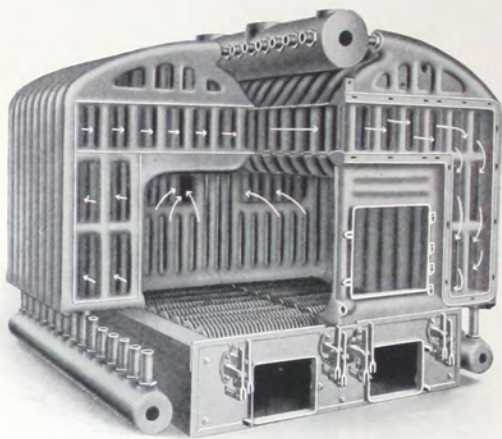

INTERIOR VIEW

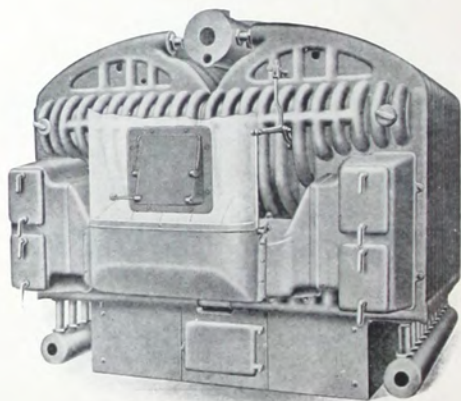

REAR VIEW — Grate Reduced
Showing Cleanout Door (in the Ashpit)

Diagram
of

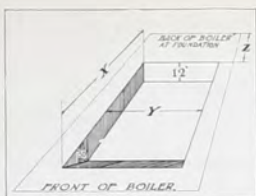

Ash
Pit
Dimensions

24 MILLS

34 MILLS

44 MILLS

No. of Secs.	Ash Pit Dimensions Inches			No. of Secs.	Ash Pit Dimensions Inches			No. of Secs.	Ash Pit Dimensions Inches		
	X	Y	Z		X	Y	Z		X	Y	Z
5	30	24	1/2	6	35	28	1/2	7	41	38	1/2
6	36	24	1/2	7	41	28	1/2	8	47	38	1/2
7	42	24	1/2	8	47	28	1/2	9	53	38	1/2
8	48	24	1/2	9	53	28	1/2	10	59	38	1/2
9	54	24	1/2	10	59	28	1/2	11	65	38	1/2
10	60	24	1/2	11	65	28	1/2	12	71	38	1/2
				12	71	28	1/2	13	77	38	1/2
				13	77	28	1/2	14	83	38	1/2
				14	83	28	1/2	15	89	38	1/2
								16	95	38	1/2

27 SMITH

36 SMITH

No. of Secs.	Ash Pit Dimensions, Inches							No. of Secs.	Ash Pit Dimensions, Inches						
	Grate Full Size and Grate Reduced			With Oxygen Torch					Grate Full Size and Grate Reduced			With Oxygen Torch			
	X	Y	Z	No. Secs.	X	Y	Z		X	Y	Z	No. Secs.	X	Y	Z
5	31	27	1/2					7	42	36	1/2				
6	37	27	1/2					8	48	36	1/2				
7	43	27	1/2					9	54	36	1/2				
8	49	27	1/2					10	60	36	1/2				
9	55	27	1/2					11	66	36	1/2				
10	61	27	1/2					12	62	36	10 1/2	11	44	36	22 1/2
11	67	27	1/2	10	38	27	23 1/2	12	72	36	1/2	12	50	36	22 1/2
12	62	27	11 1/2	11	44	27	23 1/2	13	68	36	10 1/2	13	56	36	22 1/2
12	73	27	1/2	12	50	27	23 1/2	13	78	36	1/2	14	62	36	22 1/2
13	68	27	11 1/2	13	56	27	23 1/2	14	68	36	16 1/2	15	68	36	22 1/2
13	79	27	1/2	14	62	27	23 1/2	14	84	36	1/2	16	74	36	22 1/2
14	68	27	17 1/2	15	68	27	23 1/2	15	74	36	16 1/2	17	80	36	22 1/2
14	85	27	1/2	16	74	27	23 1/2	15	90	36	1/2	18	86	36	22 1/2

42 SMITH

60 SMITH

No. of Secs.	Ash Pit Dimensions, Ins.							No. of Secs.	Ash Pit Dimensions, Ins.						
	Grate Full Size			Grate Reduced					Grate Full Size and Grate Reduced			With Oxygen Torch			
	X	Y	Z	X	Y	Z	X		Y	Z	X	Y	Z		
7	42	42					8	41	60	4 1/2					
8	48	42					9	47	60	4 1/2					
9	54	42					10	53	60	4 1/2					
10	60	42		36	42	24	11	59	60	4 1/2					
11	66	42		42	42	24	12	65	60	4 1/2	47	60	24		
12	72	42		48	42	24	13	71	60	4 1/2	53	60	24		
13	78	42		54	42	24	14	77	60	4 1/2	59	60	24		
14	84	42		60	42	24	15	83	60	4 1/2	65	60	24		
15				66	42	24	16	89	60	4 1/2	71	60	24		
16				72	42	30	17	83	60	16 1/2	71	60	30		
17				78	42	30	18	89	60	16 1/2	77	60	30		
							19	89	60	22 1/2	83	60	30		
							20	89	60	28 1/2	83	60	36		

H-B BOILERS



H-B Boiler
Tailored in Mountain
Ash Scarlet

The Boiler with the
Swell Front

H-B STEAM BOILER

Transverse Section—

Showing Horizontal
Fire Travel
and Large Vertical
Water Ways

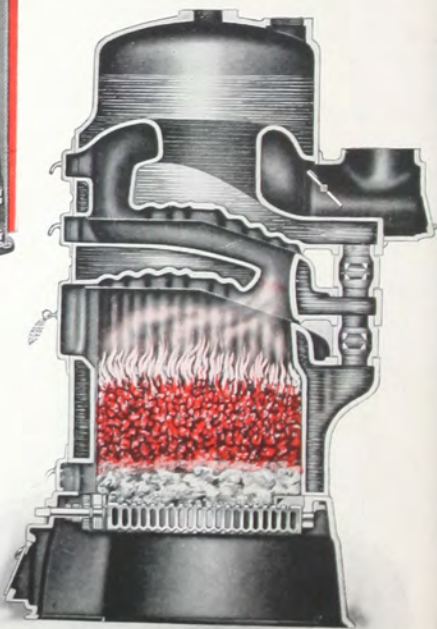

H-B Boilers

Tested to A.S.M.E. Standard Hydrostatic Pressure
Maximum Allowable Working Pressure—Steam 15 lb., Water 30 lb.

No. of Boiler	Steam Rating Feet	Water Rating Feet	Dia. of Fire Pot Inches	Area of Grate Sq. Ft.	Chimney*		Size of	
					Size Inches	Height Feet	Safety Valve	Water Relief Valve
115	250	425	15	1.19	8 x 8	25	1	1/2
217	325	550	17	1.43	8 x 8	25	1	1/2
317	375	625	17	1.43	8 x 8	30	1	1/2
219	425	700	19	1.83	8 x 8	25	1	1/2
319	475	775	19	1.83	8 x 8	30	1	1/2
221	500	825	21	2.25	8 x 8	30	1	3/4
321	550	900	21	2.25	8 x 8	30	1	3/4
223	600	1000	23	2.71	8 x 8	30	1	3/4
323	700	1150	23	2.71	8 x 12	30	1	3/4
224	650	1075	24	2.91	8 x 12	30	1	3/4
324	800	1325	24	2.91	8 x 12	30	1	3/4
227	900	1500	27	3.77	8 x 12	30	1	3/4
327	1000	1650	27	3.77	8 x 12	35	1 1/4	3/4

*For small sizes of coal or for deep beds of fuel, higher chimneys are required.

DIMENSIONS IN INCHES

Number of Boiler	115	217	219	221	223	224	227	317	319	321	323	324	327
Total Height of Boiler, Reg.	47	55 1/4	55 1/4	56 1/2	56 1/2	58	58	62 3/4	62 3/4	63 1/2	63 1/2	65 1/2	65 1/2
Total Height of Jacketed Boilers	57 1/2	58 1/2	59 3/4	59 3/4	61	61	64 3/4	65 3/4	67 1/2	67 1/2	68 7/8	68 7/8	68 7/8
Height of Ash Pit	12	12	12	12	14	14	12	12	12	12	14	14	14
Height of Fire Pot	22 1/2	22 1/2	22 1/2	22 1/2	22	22	22 1/2	22 1/2	22 1/2	22 1/2	22	22	22
Height of Intermediate Sec.							7	7	7	7	7 1/2	7 1/2	7 1/2
Height of Dome	35	20 3/4	20 3/4	22	22	22	22	20 3/4	20 3/4	22	22	22	22
Height of Water Line	39 1/2	49 3/4	49 3/4	49 3/4	49 3/4	51	51	56 3/4	56 3/4	56 3/4	56 3/4	58 1/2	58 1/2
Dist. from Floor to Smoke-Pipe Opening, Reg.	35	42	42	42	42	44	44	49	49	49	49	51 1/2	51 1/2
Dia. of S. P. Opening, Reg.	6	7	7	8	8	8	8	7	7	8	8	8	8
Dia. of S. P. Opening of Jacketed Boilers	8	8	8	9	9	9	9	8	8	9	9	9	9
Length at Floor of Jacketed Boilers	29 1/2	29 1/2	36 3/4	36 3/4	40 1/2	40 1/2	29 1/2	29 1/2	36 3/4	36 3/4	40 1/2	40 1/2	40 1/2
Length at Floor, Reg.	25	25	27 3/4	29 3/4	32	35 1/2	38 1/2	25	27 3/4	29 3/4	32	35 1/2	38 1/2
Width at Floor, Reg.	24 3/4	24 3/4	27 3/4	29 3/4	31 1/2	33 1/2	37	24 3/4	27 3/4	29 3/4	31 1/2	33 1/2	37
Width at Floor of Jacketed Boilers	29 1/2	29 1/2	34	34	40	40	29 1/2	29 1/2	34	34	40	40	40
Outside Dia. of Fire Pot	19	20 1/2	22 1/2	24 1/2	26 1/2	28 1/2	31 1/2	20 1/2	22 1/2	24 1/2	26 1/2	28 1/2	31 1/2
Outside Diameter of Intermediate Section							17	17	21	21	21	24	24
Outside Dia. of Dome	19	17	17	21	21	24	24	17	17	21	21	24	24

REGULAR TAPPINGS†

TAPPINGS ON TOP OF DOME

No. of Boiler	Size of Tappings, inches				
	3/4	1	1 1/2	2	2 1/2
	Number of Tappings				
115	1	2	2		1
217	1	1	3		1
317	1	1	3		1
219	1	1	3		1
319	1	1	3		1
221	1		3	1	1
321	1		3	1	1
223	1		3	1	1
323	1		3	1	1
224	1	1	2		2
324	1	1	2		2
227	1	1	2		2
327	1	1	2		2

Care should be taken when ordering to specify Boiler with or without Jacket.

RETURN TAPPINGS

No. 115. One 2 1/2 in. Two 1 1/2 in. Other Boilers, two 3 in.

†TAPPINGS other than those listed are SPECIAL. Order must SPECIFY SIZES.

Fire Tools and Steam Trimmings, see Page 55.

Nos. 110 and 113 Hy-Test

For Hot Water Supply

Tested at 300 lb. Hydrostatic Pressure, A. S. M. E. Standard
Maximum Allowable Working Pressure, 120 lbs.



No. 110 with Regulator
(shipped on order)

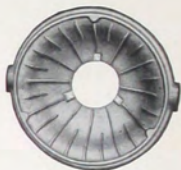

Dome



Ash Pit

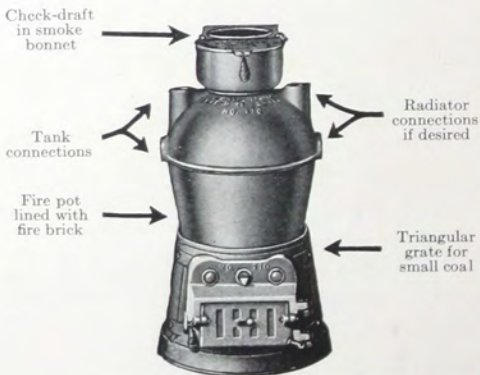

Nos. 110 and 113 Hy-Test

Galvanized Dome Sections can be Furnished for these Boilers

When Regulator is ordered the following is furnished for No. 110: - Galvanized Pipe (11") and Tee (1" x 3/4" x 1")

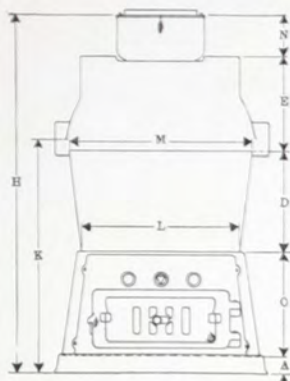

When Regulator is ordered the following is furnished for No. 113: - Galvanized Pipe (11") and Tee (1 1/2" x 3/4" x 1 1/2")

DIMENSIONS IN INCHES

Number	No. 110	No. 113
A Height of Floor Plate	1 3/8"	1 3/4"
C Height of Ash Pit	8 3/4"	8 3/4"
D Height of Fire Pot Section	8 1/2"	8 1/2"
E Height of Dome	6 1/2"	7 7/8"
N Height from Top Tapping to Top of Smoke Bonnet	3 3/8"	3 3/4"
M Outside Diameter of Dome	12 5/8"	15 3/8"
L Outside Diameter of Fire Pot at Base	10 1/2"	13 1/2"
H Total Height	29"	30 1/2"
K Height to Center of Side Tapping	19 3/8"	19 7/8"
Diameter of Ash Pit at Base	13 5/8"	16 5/8"
Size of Tappings	1"	1 1/2"

Size of S. P. Opening 3" x 6"

Performance, No. 110 HY-TEST

Rated Tank Capacity = 40 gallons

Grate Surface . . .	0.360 sq. ft.	Fuel Surface . . .	0.442 sq. ft.
Tables based on: Heat value of coal			12,500 B. t. u.
Weight of cu. ft. of coal 55 lb.		Weight of gallon of water	8.34 lb.

Gallons of water per hour						B. t. u. req. per hr.	Efficiency per cent.	Fuel per hr. lb.	Rate com. per sq. ft.		Periods of Firing hr.	
Degrees Rise, Fahr.									Fuel Surf.	Gr. Surf.		
20	40	60	80	100	120	140						
Available Fuel Thickness, 8.5 inches = 17 lb. = 212,500 B. t. u.												
40	20	13	10	8	7	6	6,650	49	1.09	2.5	3.0	15.6
35	18	12	9	7	6	5	5,850	50	0.94	2.1	2.6	18.1
30	15	10	8	6	5	4	5,000	49	0.82	1.9	2.3	20.7
25	13	8	6	5	4	4	4,150	48	0.69	1.6	1.9	24.6

Performance, No. 113 HY-TEST

Rated Tank Capacity = 80 gallons

Grate Surface . . .	0.645 sq. ft.	Fuel Surface . . .	0.753 sq. ft.
---------------------	---------------	--------------------	---------------

Available Fuel Thickness, 8.5 inches = 29 lb. = 362,500 B. t. u.												
75	38	25	19	15	13	11	12,500	50	2.00	2.7	3.1	14.5
65	33	22	16	13	11	9	10,850	50	1.74	2.3	2.7	16.7
55	28	18	14	11	9	8	9,150	49	1.49	2.0	2.3	19.5
45	23	15	11	9	8	6	7,500	48	1.25	1.7	1.9	23.2

No. 17 Hy-Test Boiler

For Hot Water Supply

Maximum Allowable Working Pressure, 120 lb.

A.S.M.E. Standard

Tested at 300 lb. per sq. in. Hydrostatic Pressure



Front
View

Interior
View

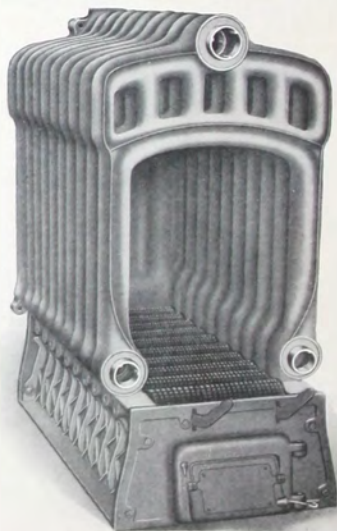

No. 17 Hy-Test Boiler

For Hot Water Supply

No. of Secs.	Rat-ings† Gals.	Fuel Surface Sq. Ft.	Size of Fire Pot Inches	Area of Grate Sq. Ft.	Chimney*		Size of Water Relief Valve A. S. M. E. Stand'd	Weight 1 cu. ft. coal = 55 lb.			
					Size Ins.	H'ght Ft.		Available Fuel—lb.			
								Fuel Thickness			
								12 in.	10 in.	8 in.	6 in.
4	450	1.5	18 x 12	1.17	8 x 8	30		83	69	55	41
5	600	2.0	18 x 16	1.56	8 x 8	30	½ in.	110	92	73	55
6	750	2.5	18 x 20	1.94	8 x 8	35		138	115	92	69
7	900	3.0	18 x 24	2.33	8 x 8	35		165	138	110	83
8	1050	3.5	18 x 28	2.72	8 x 8	40	¾ in.	193	160	128	96
9	1200	4.0	18 x 32	3.11	8 x 10	40		220	183	147	110
10	1350	4.5	18 x 36	3.50	8 x 10	45		248	206	165	124

*For small sizes of coal or for deep beds of fuel, higher chimneys are required.

†Boilers are rated to raise Tank Capacity 100 degrees in six hours.

DIMENSIONS

Number of Sections	Total Length of Boiler Inches	Length at Foundation Inches
4	29¼	18½
5	33¼	22½
6	37¼	26½
7	41¼	30½
8	45¼	34½
9	49¼	38½
10	53¼	42½

Width at Foundation 23 in.

Width of Boiler 24½ in.

Height of Boiler 50½ in.

Height of Ash Pit 12 in.

Length of Grate Bar 14 in.

Dist. betw. center of Grates 4 in.

Dist. from Floor to center

of Smoke-Pipe Opening 40¼ in.

Dia. S. P. Opening 8 in.

Four brass washout plugs are furnished with boiler.

Water relief valve, altitude gauge and thermometer are NOT furnished.

REGULAR TAPPINGS

Tappings	No.	Size	Location
Supply	1	3 in.	Top
Water Relief Valve (see table of W. R. Valve sizes above)	1	3 in.	Top
Returns	1	3 in.	Rear
Draw off	2	¾ in.	Sides of Front Section
Altitude Gauge	1	¾ in.	Top of Front Section
Thermometer	1	¾ in.	Top of Front Section
Washout Holes (at bottom)	4	2½ in.	Two in Front, Two in Rear

Fire Tools, see Page 55.

Hy-Test Boilers are shipped knocked down.

No. 24 Hy-Test Boiler

For Hot Water Supply

Tested at 300 lbs. Hydrostatic pressure, A. S. M. E. Standard
Maximum allowable working pressure, 120 lbs.



Front View

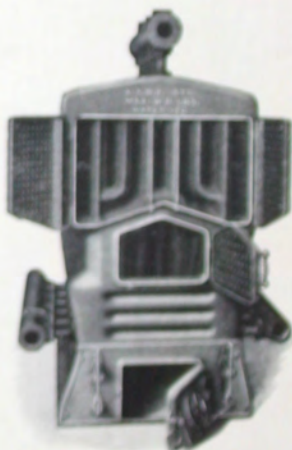

Doors Open

No. 24 Hy-Test Boiler

For Hot Water Supply

No. of Secs.	Tank Capacity Gallons†	Fuel Surface Sq. Ft.	Size of Fire Pot Inches	Area of Grate Sq. Ft.	Chimney*		Water Relief Valve	Wt. 1 cu. ft. Coal = 55 lb.			
					Size Inches	H'ght Ft.		Available Fuel Pounds			
								Fuel Thickness			
12"	10"	8"	6"								
5	1200-1500	3.85	20 x 24	3.33	8 x 12	25	3/4	212	176	141	106
6	1500-1800	4.80	20 x 30	4.17	8 x 12	30	3/4	264	220	176	132
7	1800-2100	5.75	20 x 36	5.00	12 x 12	25	3/4	316	264	211	158
8	2100-2400	6.70	20 x 42	5.84	12 x 12	30	1	369	307	246	184
9	2400-2700	7.65	20 x 48	6.67	12 x 12	35	1	421	351	286	210
10	2700-3000	8.60	20 x 54	7.50	12 x 16	35	1	473	394	315	237

*For small sizes of coal or for deep beds of fuel, higher chimneys are required.

†Boilers are rated to raise Tank Capacity 100 degrees in six hours.

DIMENSIONS

No. of Secs.	Length at Foundation Inches	Total Length Boiler Inches	Diameter of Smoke Pipe Opening Inches	Width of Foundation
5	32	48	9	29 in.
6	38	54	9	32 in.
7	44	60	10	48 in.
8	50	66	10	66 in.
9	56	72	12	12 in.
10	62	78	12	20 in.

Height of Boiler 66 in.
 Height of Ash Pit 12 in.
 Length of Grate Bars 20 in.
 Dist. betw. Centers of Grates 6 in.
 Dist. from Floor to Center of Smoke-Pipe Opening 38 in.

TAPPINGS ON TOP OF SUPPLY DRUM

No. of Secs. Water	Size of Tappings, in.				
	1 1/4	1 1/2	2	2 1/2	3
No. of Tappings					
5	1	.	2	.	1
6	.	1	2	.	1
7	.	1	2	.	1
8	.	.	2	.	1
9	.	.	1	1	1
10	.	.	1	1	1

REGULAR TAPPINGS† Supply Drum

Outside Diameter 6 in.
 Tapped for 1 1/2 in. Locknut Nipples. Ends tapped ... 2 1/2 in.

RETURN DRUMS

Outside Diameter 6 in.
 Tapped for 1 1/2 in. Locknut Nipples. Top and Bottom at opposite ends tapped ... 2 in.
 Side tapped 1 1/4 in.
 Front Ends tapped 2 1/2 in.
 Rear Ends tapped 4 in.

Fire Tools, see Page 55.

2 Brass Washout Plugs are furnished.

†TAPPINGS other than those listed are SPECIAL. Order must SPECIFY SIZES.

34 Hy-Test Boiler

*Tested at 200 lb. per sq. in. Hydrostatic Pressure, A. S. M. E.
Standard Maximum Allowable Working Pressure, 80 lbs.*

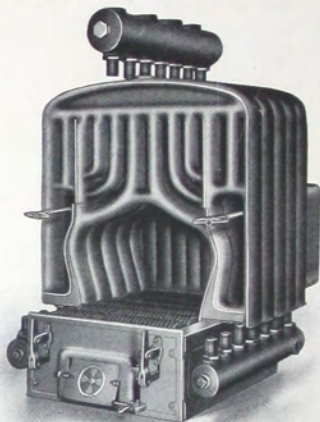

Hy-Test No. 34 Interior

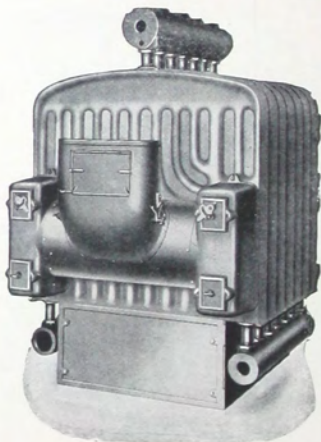

Hy-Test No. 34 Rear View

34 Hy-Test Boiler

Number of Sections	Fuel Surface sq. ft.	Size of Fire Pot inches	Area Grate sq. ft.	Chimney*		Water Relief Valve inches
				Size inches	Height feet	
6	7.08	34 x 30	5.83	12 x 16	30	1
7	8.50	34 x 36	7.00	12 x 16	35	1
8	9.92	34 x 42	8.17	16 x 16	30	1
9	11.33	34 x 48	9.33	16 x 16	35	1
10	12.75	34 x 54	10.50	16 x 16	40	1 $\frac{1}{4}$
11	14.17	34 x 60	11.67	16 x 20	30	1 $\frac{1}{4}$
12	15.58	34 x 66	12.83	16 x 20	35	1 $\frac{1}{4}$
13	17.00	34 x 72	14.00	16 x 20	40	1 $\frac{1}{4}$
14	18.42	34 x 78	15.17	16 x 20	45	1 $\frac{1}{4}$

*For small sizes of coal or for deep beds of fuel, higher chimneys are required. Information as to proper size furnished on request.

Number of Sections	Total Length inches	Length at Foundation inches	Size of S. P. Opening inches
6	60	37	12 x 12 = 12 Rd.
7	66	43	12 x 12 = 12 Rd.
8	72	49	12 x 12 = 12 Rd.
9	78	55	12 $\frac{1}{2}$ x 15 $\frac{1}{2}$ = 14 Rd.
10	84	61	12 $\frac{1}{2}$ x 15 $\frac{1}{2}$ = 14 Rd.
11	90	67	12 $\frac{1}{2}$ x 15 $\frac{1}{2}$ = 14 Rd.
12	96	73	12 x 20 = 16 Rd.
13	102	79	12 x 20 = 16 Rd.
14	108	85	12 x 20 = 16 Rd.

Dimensions

Width at Foundation.....	36"
Width at Boiler.....	51"
Height of Boiler.....	78"
Height of Ash Pit.....	16"
Length of Grate Bars.....	28"
Distance between Centers of Grates.....	6"
Size of Supply Drum Nipples.....	2" x 4 $\frac{1}{2}$ "
Size of Return Drum Nipples.....	1 $\frac{1}{2}$ " x 7"
Distance from floor to Smoke-Pipe opening.....	49"

REGULAR TAPPINGS†

Tappings on Top of Supply Drum

Number of Sections	Size of Tappings, inches				
	2	2 $\frac{1}{2}$	3	4	5
	Number of Tappings				
6	1	.	2	1	.
7	1	.	2	1	.
8	1	.	2	1	.
9	.	1	1	1	1
10	.	1	1	1	1
11	.	1	1	1	1
12	.	1	1	1	1
13	.	.	1	2	1
14	.	.	1	2	1

Supply Drum

Outside Diameter.....	8"
Tapped for 2" Lock-Nut Nipples	
Each end tapped.....	2 $\frac{1}{2}$ "

Return Drums

Outside Diameter.....	6"
Tapped for 1 $\frac{1}{2}$ " Lock-Nut Nipples	
Under side tapped.....	1 $\frac{1}{4}$ "
Front ends tapped.....	2 $\frac{1}{2}$ "
Rear ends tapped.....	4"
Side tapped.....	2"

†TAPPINGS other than those listed are SPECIAL. Order must SPECIFY SIZES.

2 Brass Washout Plugs are furnished.

44 Hy-Test Boiler

*Tested at 200 lbs. Hydrostatic pressure, A. S. M. E. Standard
Maximum allowable working pressure, 80 lbs.*

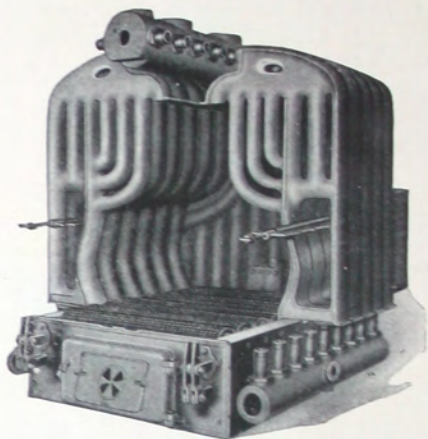

No. 44 Hy-Test Interior

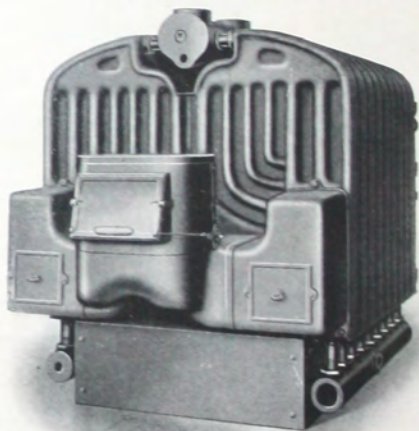

No. 44 Hy-Test Rear View

44 Hy-Test Boiler

Number of Sections	Fuel Surface sq. ft.	Size of Fire Pot inches	Area Grate sq. ft.	Chimney*		Water Relief Valve inches
				Size inches	Height	
7	10.63	44 x 36	9.50	16 x 16	35	1
8	12.40	44 x 42	11.10	16 x 20	35	1 $\frac{1}{4}$
9	14.17	44 x 48	12.70	16 x 20	40	1 $\frac{1}{4}$
10	15.94	44 x 54	14.25	16 x 20	45	1 $\frac{1}{4}$
11	17.71	44 x 60	15.80	20 x 20	35	1 $\frac{1}{2}$
12	19.48	44 x 66	17.40	20 x 20	40	1 $\frac{1}{2}$
13	21.25	44 x 72	19.00	20 x 24	35	1 $\frac{1}{2}$
14	23.02	44 x 78	20.60	20 x 24	40	1 $\frac{1}{2}$
15	24.79	44 x 84	22.20	20 x 24	45	1 $\frac{1}{2}$
16	26.56	44 x 90	23.75	20 x 24	50	1 $\frac{1}{2}$

*For small sizes of coal or for deep beds of fuel, higher chimneys are required. Information as to proper size furnished on request.

Number of Sections	Total Length inches	Length at Foundation inches	Size of S. P. Opening inches
7	72	43	13 x 16 $\frac{1}{4}$ = 15 Rd.
8	78	49	13 x 16 $\frac{1}{4}$ = 15 Rd.
9	84	55	13 x 16 $\frac{1}{4}$ = 15 Rd.
10	90	61	13 x 22 $\frac{1}{2}$ = 18 Rd.
11	96	67	13 x 22 $\frac{1}{2}$ = 18 Rd.
12	102	73	13 x 22 $\frac{1}{2}$ = 18 Rd.
13	108	79	15 x 24 $\frac{1}{2}$ = 20 Rd.
14	114	85	15 x 24 $\frac{1}{2}$ = 20 Rd.
15	120	91	15 x 24 $\frac{1}{2}$ = 20 Rd.
16	126	97	15 x 24 $\frac{1}{2}$ = 20 Rd.

Dimensions

Width at Foundation	46"
Width of Boiler	64"
Height of Boiler	75"
Height of Ashpit	16"
Length of Grate Bar	38"
Distance between Centers of Grates	6"
Size of Supply Drum Nipples	2" x 4 $\frac{1}{2}$ "
Size of Return Drum Nipples	2" x 7"
Distance from Floor to Smoke-Pipe Opening	50"

REGULAR TAPPINGS†

Tappings on Top of Supply Drum

Number of Sections	Size of Tappings, inches					
	2 $\frac{1}{2}$ "	3"	3 $\frac{1}{2}$ "	4"	5"	6"
7	1	1	.	1	1	.
8	1	1	.	1	1	.
9	.	1	.	1	1	1
10	.	1	.	1	1	1
11	.	1	.	1	1	1
12	.	1	.	1	2	.
13	.	.	1	.	1	2
14	.	.	1	.	1	2
15	.	.	1	.	1	2
16	.	.	1	.	1	2

Supply Drum

Outside Diameter	10
Tapped for 2" Lock-Nut Nipples	
Front end tapped	2 $\frac{1}{2}$ "
Rear end tapped, one 2 $\frac{1}{2}$ " and one 2"	

Return Drums

Outside Diameter	8"
Tapped for 2" Lock-Nut Nipples	
Front end tapped	2 $\frac{1}{2}$ "
Rear end tapped	5"
Side tapped	2"

†TAPPINGS other than those listed are SPECIAL. Order must SPECIFY SIZES.

2 Brass Washout Plugs are furnished.

Menlo Water Boiler

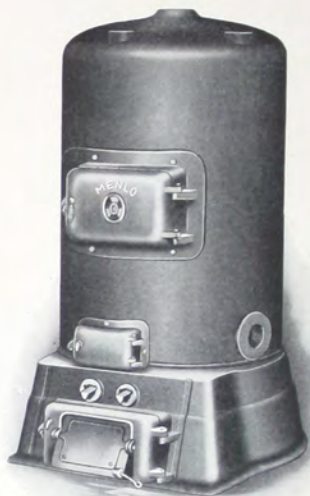

Nos. 16-18-20

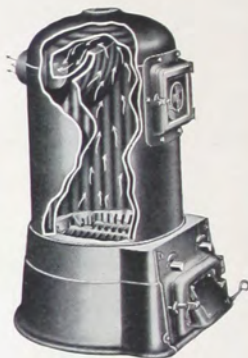

Nos. 10-12-14

No. of Boiler	Rating Feet	Dia. of Fire Pot Inches	Area of Grate Sq. Ft.	Chimney		Size Water Relief Valve	Max. Allo. Working Pressure Lb. Per Sq. In.	Tested Hydro. Pressure Lb. Per Sq. In.
				Dia. Inches	Height Feet			
10	200	10	.55	8	25	1/2	80	200
12	300	12	.79	8	25	1/2	70	175
14	400	14	1.12	8	25	1/2	60	150
16	500	16	1.55	8	30	1/2	30	75
18	600	18	1.89	9	30	1/2	30	75
20	800	20	2.40	10	35	3/4	30	75

DIMENSIONS IN INCHES

Number of Boiler	10	12	14	16	18	20
Total Hgt. of Boiler	33 1/2	35	39	50	50	51
Height of Ash Pit...	9 1/2	9 1/2	12	12	12	12
Hgt. of Water Line	44	44	45
Height of Dome...	24	25 1/2	27	38	38	39
Outside Dia. Dome	15	17 1/2	20	22	24	26
Dis. Floor to center S.P. Opening...	26 1/2	27 1/4	31 1/8	37 1/2	37 1/2	38
Dia. S.P. Opening...	5	5	6	7	7	8
Length at Floor...	18 1/4	20 3/4	25	27 3/4	29 3/4	32
Width at Floor...	18 1/4	20 3/4	24 3/4	27 1/2	29 1/4	31 1/2

REGULAR TAPPINGS

No.	Supply	Return
10	1-2"	3-2"
12	1-2"	3-2"
14	1-2 1/2"	3-2"
16	1-3", 2-1 1/2", 2-1"	1-3", 2-2"
18	1-3", 2-1 1/2", 2-1"	1-3", 2-2"
20	1-3", 2-1 1/2", 2-1"	1-3", 2-2"

Menlo Boilers

For Hot Water Supply

Galvanized
Dome Sections
can be Furnished
for these
Boilers.



NO. 12 MENLO

RATINGS

A. S. M. E Standard

Number of Boiler	Diameter of Fire Pot Inches	Tank Capacity Gallons*	Maximum All-Working Pressure Pounds	Tested to Hydrostatic Pressure Pounds
10	10	125	80	200
12	12	175	70	175
14	14	250	60	150

DIMENSIONS IN INCHES

Number	10	12	14
Height of Dome.....	24	25½	27
Height of Ash Pit.....	9½	9½	12
Total Height of Boiler.....	33½	35	39
Length at Floor.....	18¼	20¾	25
Width at Floor.....	18¼	20¾	24¾
Diameter of Dome.....	15	17½	20
Diameter of Smoke Pipe.....	5	5	6
Height to Center of S.P. Opening	26¼	27¼	31½

REGULAR TAPPINGS

Number of Boiler	Supply Tapping	Return Tapping	Size Water Relief Valves
10	One 2"	Three 2"	½
12	One 2"	Three 2"	¾
14	One 2½"	Three 2"	¾

*Boilers rated to raise Tank Capacity 100 degrees in six hours.

Grates

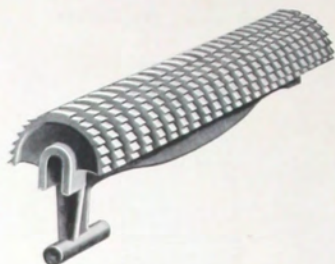

REED GRATE BAR

Reed Grate standard for all sectional boilers.



REED BUCKWHEAT GRATE

Buckwheat Coal Grate shipped on special order.



SEGMENT GRATE BAR

Segment Grate shipped on special order for Bituminous Coal and Anthracite Coal of fine grade.

Fire Tools Furnished

16 Smith
24 Mills
34 Mills
H. B. Boiler

} Poker, Flue Brush and Handle

44 Mills
27 Smith
36 Smith
42 Smith
60 Smith
17 Hy-Test

} Hoe, Poker, Flue Brush and Handle

27 Smith Oxygen Torch
36 Smith Oxygen Torch
60 Smith Oxygen Torch

} Hoe, Rake, Slice Bar,
Flue Brush and Handle

Menlo Boiler Poker

STEAM TRIMMINGS FURNISHED

Steam Gage with Cock, Water Column complete, two Gage Cocks, two Water Gage Cocks with glass, Damper Regulator complete, Pipe and Fittings for Steam Trimming and Steam Gage Syphon.

ASBESTOS PLASTER

Plaster is furnished in order that the joints between the sections can be made and the boiler fired before covering the boiler complete. A sufficient amount of plaster is furnished for this purpose only.

DRAFT DISTRIBUTORS FOR MILLS BOILERS

The Draft Distributors in the side flues, under average conditions should be turned to horizontal positions (flat across flues). In this position they do not diminish the area of the flues. If boiler is connected to a poor chimney, turn draft distributors to vertical positions.

Basis for Computing Size of Boiler

Smith Boilers are conservatively rated from scientific laboratory tests.

1. STEAM BOILER ratings are based on maintaining two pounds pressure at the boiler.

2. WATER BOILER ratings are based on the water being maintained at a temperature of 180 degrees at the boiler.

3. SUFFICIENT RADIATION must be installed to easily raise and maintain a temperature of 70 degrees.

4. Usual allowance must be made for the use of PIPE COILS, WALL RADIATORS, DIRECT-INDIRECT RADIATORS, INDIRECT RADIATION AND CONTINGENCIES.

(a) PIPE COILS or WALL RADIATORS. Each foot of surface is considered equivalent to $1\frac{1}{4}$ feet direct radiation.

(b) DIRECT-INDIRECT RADIATORS. Each foot of surface is considered equivalent to $1\frac{1}{3}$ feet of direct radiation.

(c) INDIRECT RADIATION in a GRAVITY SYSTEM. Each foot of surface is considered equivalent to 2 feet of direct radiation.

(d) INDIRECT RADIATION in a FAN SYSTEM. Each pound of steam condensed per hour is equivalent to 4 feet of direct steam radiation.

(e) STORAGE TANKS for HEATING WATER for HOT WATER SUPPLY. Each gallon storage capacity is considered equivalent to 2 feet of direct steam radiation or 3 feet of direct water radiation.

5. Additional allowance must be made for uncovered piping, etc.

6. LISTED RATINGS of boilers are determined by adding 50% to the NET amount of DIRECT cast-iron RADIATION. (See paragraph 4.)

(a) The above 50% addition is equivalent to a deduction of $33\frac{1}{3}\%$ from listed ratings.

7. RATINGS of boilers are based on solid fuel having a heat content of 12,500 B.L.U. per pound.

The **NEW**

"144"



THE H. B. SMITH CO.

Full Surface Radiator

“144”

New

The H. B. Smith full surface Tube Radiator.

In keeping with our policy for three-quarters of a century of assuring quality and value to the trade and public we offer Full Surface Radiation. Designed not to see how little but how much could be given the purchaser.

The 144 square inches of actual surface for each rated foot guarantees performance.

Steam and Water tested. Insures against breakage and leaks, protecting your pocket and our reputation.

Most manufacturers test their Radiators with Water but not Steam.

Surpassing beauty of design without sacrifice of essential strength.

$\frac{1}{8}$ " larger tube diameter than the average tube radiation = 20% larger inside cross tube area = 20% larger inside cubic capacity, resulting in freer and better circulation for steam, vapor or water.

Positively no core sand.

Full surface, strength, character and beauty of appearance in complete harmony with modern ideas of interior decoration characterize

“144”

The H. B. Smith Company's New Tube Radiation

Smith "144" Radiator



Three Tube

Smith "144" Radiator

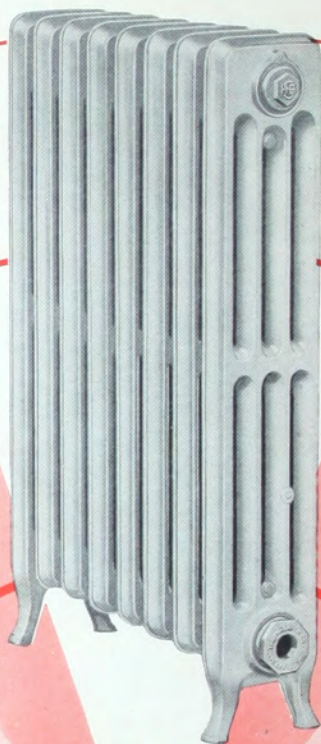

Four Tube

Smith "144" Radiator

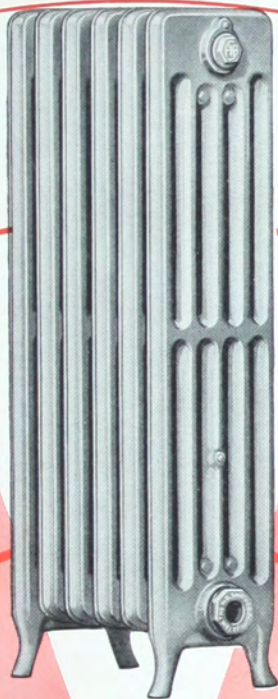

Five Tube

Smith "144" Radiator

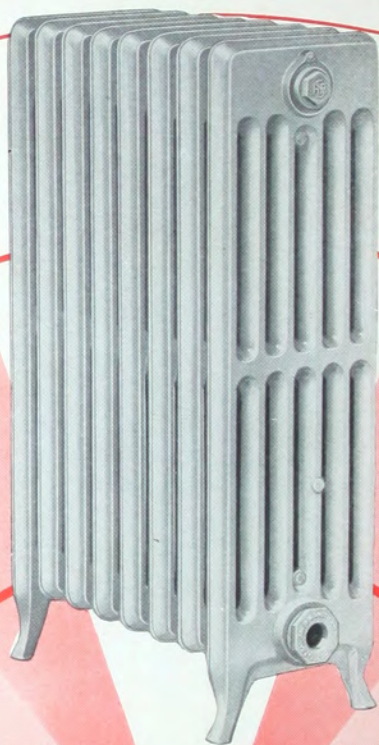

Six Tube

Smith "144" Radiator

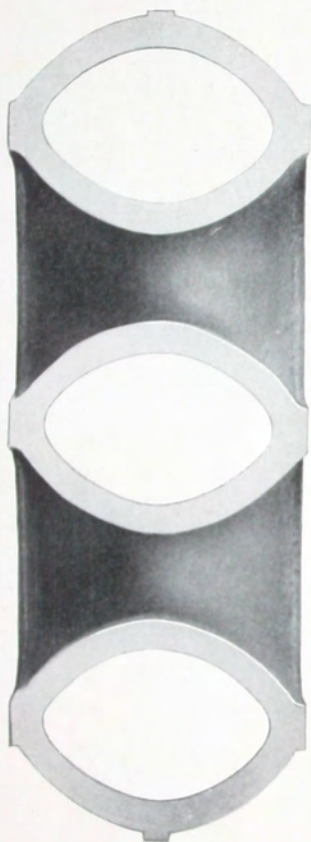

Actual Size Illustration showing the Ample Areas for Travel of Steam, Water, or Vapor

H. B.

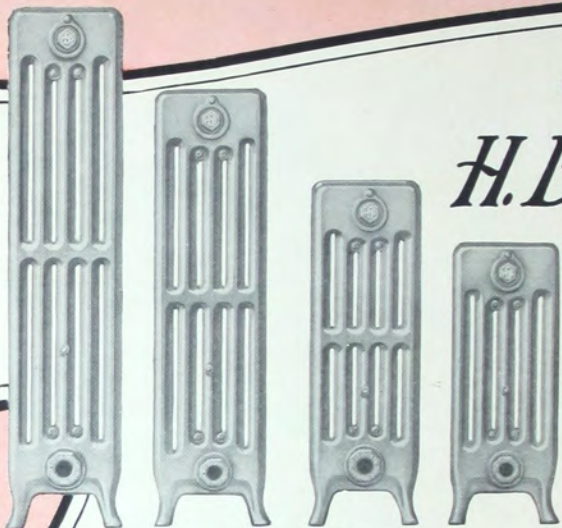

Five Tubes

"144"

Radiator

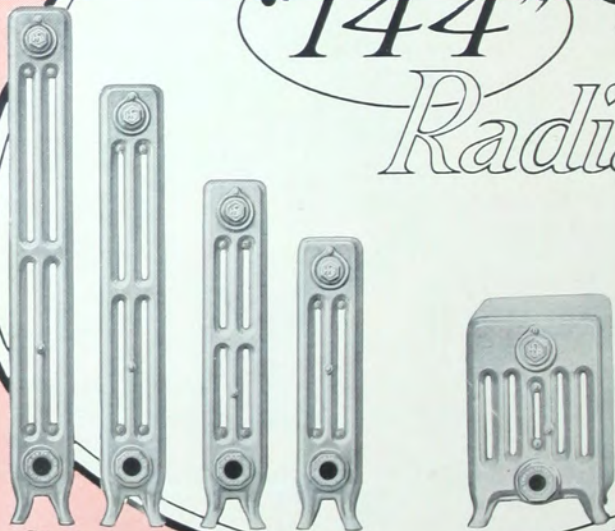

Three Tubes

2
MITH

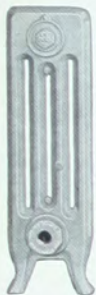

all Surface

Four Tubes

tor

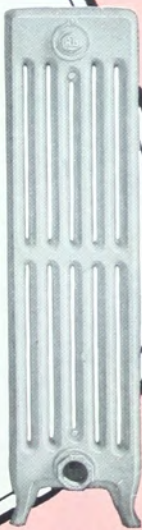

Six Tubes

Smith "144" Radiators

Steam or Water Radiating Surface in Feet

Sec- tions	Total* Length ft. - in.	3-TUBE HEIGHT				4-TUBE HEIGHT			
		37"	32"	25"	21"	37"	32"	25"	21"
		3 ft. per sec.	2½ ft. per sec.	2 ft. per sec.	1½ ft. per sec.	4 ft. per sec.	3½ ft. per sec.	2½ ft. per sec.	2 ft. per sec.
3	0 - 7½	9	7½	6	4½	12	10	7½	6
4	0 - 10	12	10	8	6	16	13½	10	8
5	1 - ½	15	12½	10	7½	20	16½	12½	10
6	1 - 3	18	15	12	9	24	20	15	12
7	1 - 5½	21	17½	14	10½	28	23½	17½	14
8	1 - 8	24	20	16	12	32	26½	20	16
9	1 - 10½	27	22½	18	13½	36	30	22½	18
10	2 - 1	30	25	20	15	40	33½	25	20
11	2 - 3½	33	27½	22	16½	44	36½	27½	22
12	2 - 6	36	30	24	18	48	40	30	24
13	2 - 8½	39	32½	26	19½	52	43½	32½	26
14	2 - 11	42	35	28	21	56	46½	35	28
15	3 - 1½	45	37½	30	22½	60	50	37½	30
16	3 - 4	48	40	32	24	64	53½	40	32
17	3 - 6½	51	42½	34	25½	68	56½	42½	34
18	3 - 9	54	45	36	27	72	60	45	36
19	3 - 11½	57	47½	38	28½	76	63½	47½	38
20	4 - 2	60	50	40	30	80	66½	50	40
21	4 - 4½	63	52½	42	31½	84	70	52½	42
22	4 - 7	66	55	44	33	88	73½	55	44
23	4 - 9½	69	57½	46	34½	92	76½	57½	46
24	5 - 0	72	60	48	36	96	80	60	48
25	5 - 2½	75	62½	50	37½	100	83½	62½	50
26	5 - 5	78	65	52	39	104	86½	65	52
27	5 - 7½	81	67½	54	40½	108	90	67½	54
28	5 - 10	84	70	56	42	112	93½	70	56
29	6 - ½	87	72½	58	43½	116	96½	72½	58
30	6 - 3	90	75	60	45	120	100	75	60

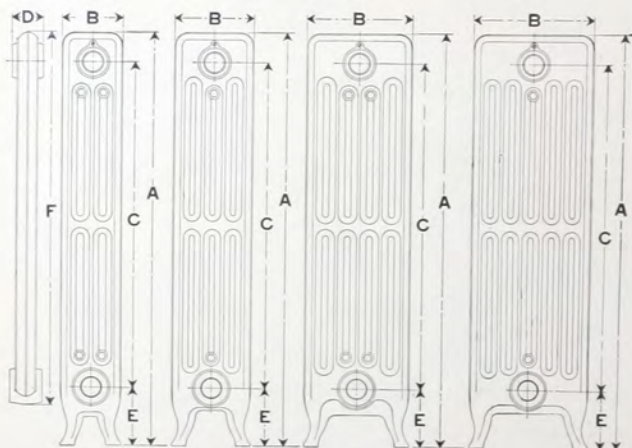

Regular Tappings See Page 73

Smith "144" Radiators

Steam or Water

Radiating Surface in Feet

Sec-tions	Total* Length ft. - in.	5-TUBE HEIGHT				6-TUBE HEIGHT				
		37"	32"	25"	21"	37"	32"	25"	21"	14"
		5 1/8 ft. per sec.	4 1/4 ft. per sec.	3 3/4 ft. per sec.	2 1/2 ft. per sec.	6 ft. per sec.	5 ft. per sec.	3 3/4 ft. per sec.	3 ft. per sec.	2 ft. per sec.
3	0 - 7 1/2	15 3/8	12 3/4	9 3/4	7 1/2	18	15	11 1/4	9	6
4	0 - 10	20 1/2	17	13	10	24	20	15	12	8
5	1 - 1/2	25 3/8	21 1/4	16 1/4	12 1/2	30	25	18 3/4	15	10
6	1 - 3	30 3/4	25 1/2	19 1/2	15	36	30	22 1/2	18	12
7	1 - 5 1/2	35 7/8	29 3/4	22 3/4	17 1/2	42	35	26 1/4	21	14
8	1 - 8	41	34	26	20	48	40	30	24	16
9	1 - 10 1/2	46 1/4	38 1/2	29 1/2	22 1/2	54	45	33 3/4	27	18
10	2 - 1	51 1/4	42 1/2	32 1/2	25	60	50	37 1/2	30	20
11	2 - 3 1/2	56 3/4	46 3/4	35 3/4	27 1/2	66	55	41 1/4	33	22
12	2 - 6	61 1/2	51	39	30	72	60	45	36	24
13	2 - 8 1/2	66 5/8	55 1/2	42 1/4	32 1/2	78	65	48 3/4	39	26
14	2 - 11	71 3/4	59 1/2	45 1/2	35	84	70	52 1/2	42	28
15	3 - 1 1/2	76 7/8	63 3/4	48 3/4	37 1/2	90	75	56 1/4	45	30
16	3 - 4	82	68	52	40	96	80	60	48	32
17	3 - 6 1/2	87 1/8	72 1/4	55 1/4	42 1/2	102	85	63 3/4	51	34
18	3 - 9	92 1/4	76 1/2	58 1/2	45	108	90	67 1/2	54	36
19	3 - 11 1/2	97 3/8	80 3/4	61 3/4	47 1/2	114	95	71 1/4	57	38
20	4 - 2	102 1/2	85	65	50	120	100	75	60	40
21	4 - 4 1/2	107 5/8	89 1/4	68 1/4	52 1/2	126	105	78 3/4	63	42
22	4 - 7	112 3/4	93 1/2	71 1/2	55	132	110	82 1/2	66	44
23	4 - 9 1/2	117 7/8	97 3/4	74 3/4	57 1/2	138	115	86 1/4	69	46
24	5 - 0	123	102	78	60	144	120	90	72	48
25	5 - 2 1/2	128 1/8	106 1/4	81 1/4	62 1/2	150	125	93 3/4	75	50
26	5 - 5	133 1/4	110 1/2	84 1/2	65	156	130	97 1/2	78	52
27	5 - 7 1/2	138 3/8	114 3/4	87 3/4	67 1/2	162	135	101 1/4	81	54
28	5 - 10	143 1/2	119	91	70	168	140	105	84	56
29	6 - 1/2	148 5/8	123 1/4	94 1/4	72 1/2	174	145	108 3/4	87	58
30	6 - 3	153 3/4	127 1/2	97 1/2	75	180	150	112 1/2	90	60

*Add 1/2 inch for each bushing.

†Regularly furnished.

Can be supplied on SPECIAL ORDER with six inch legs (E) or without legs. No other special legs can be supplied.

THREE TUBE					Height of Legless Radiators
A	B	C	D	E†	
37		30 1/4			34 1/8
32	4 1/2	24 1/4	2 1/2	4 1/2	28 3/8
25		18 1/8			22 3/8
21		14 1/4			18
FOUR TUBE					
37		30 1/4			34 1/8
32	6	24 1/4	2 1/2	4 1/2	28 3/8
25		18 1/8			22 3/8
21		14 1/4			18
FIVE TUBE					
37		30 1/4			34 1/8
32		24 1/4			28 3/8
25	8	18 1/8	2 1/2	4 1/2	22 3/8
21		14 1/4			18
SIX TUBE					
37		30 1/4			34 1/8
32		24 1/4			28 3/8
25	9 1/8	18 1/8	2 1/2	4 1/2	22 3/8
21		14 1/4			18
14		8 1/4		3	12 3/4

Regular Tappings See Page 73

No. 10 T Adjustable Wall Bracket

For Smith "144" Radiators

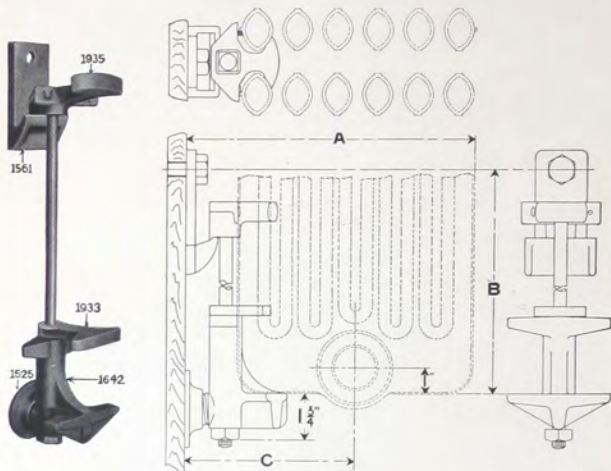

THREE TUBE	Height	37"	32"	25"	21"	
	Rod	21"	21"	15 1/2"	15 1/2"	
	A	6 3/4"	6 3/4"	6 3/4"	6 3/4"	
	B	18 7/8" - 20 7/8"	18 7/8" - 20 7/8"	12 3/8" - 15 3/8"	12 3/8" - 15 3/8"	
	C	4 1/4" - 4 5/8"	4 1/4" - 4 5/8"	4 1/4" - 4 5/8"	4 1/4" - 4 5/8"	
FOUR TUBE	Height	37"	32"	25"	21"	
	Rod	21"	21"	15 1/2"	15 1/2"	
	A	8"	8"	8"	8"	
	B	18 7/8" - 20 7/8"	18 7/8" - 20 7/8"	12 3/8" - 15 3/8"	12 3/8" - 15 3/8"	
	C	4 7/8" - 5 1/4"	4 7/8" - 5 1/4"	4 7/8" - 5 1/4"	4 7/8" - 5 1/4"	
FIVE TUBE	Height	37"	32"	25"	21"	
	Rod	21"	21"	15 1/2"	15 1/2"	
	A	10"	10"	10"	10"	
	B	18 7/8" - 20 7/8"	18 7/8" - 20 7/8"	12 3/8" - 15 3/8"	12 3/8" - 15 3/8"	
	C	5 7/8" - 6 1/4"	5 7/8" - 6 1/4"	5 7/8" - 6 1/4"	5 7/8" - 6 1/4"	
SIX TUBE	Height	37"	32"	25"	21"	14"
	Rod	21"	21"	15 1/2"	15 1/2"	7 3/4"
	A	11 1/8"	11 1/8"	11 1/8"	11 1/8"	11 1/8"
	B	18 7/8" - 20 7/8"	18 7/8" - 20 7/8"	12 3/8" - 15 3/8"	12 3/8" - 15 3/8"	4 5/8" - 7 5/8"
		C	6 7/16" - 6 11/16"	6 7/16" - 6 11/16"	6 7/16" - 6 11/16"	6 7/16" - 6 11/16"

Parts of No. 10 T Bracket for Smith "144" Radiators

1933 Clip, 1935 Top Bracket (with screw), 1642 Bottom Bracket, 1525 Foot Adjusting Nut, 1561 Hanger.

No. 10 P Adjustable Wall Bracket

For Princess Column Radiators

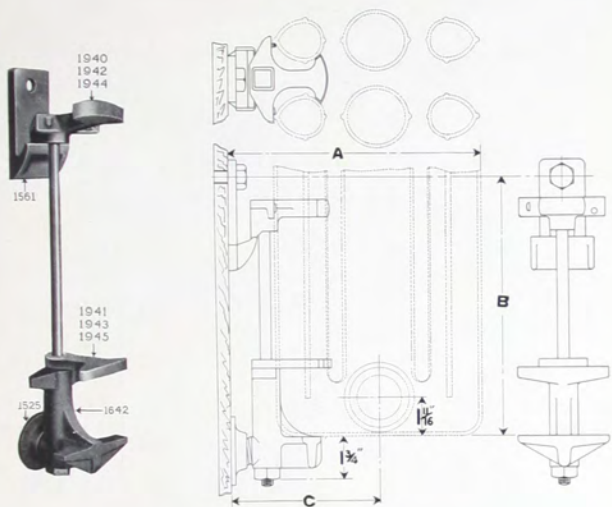

Style	Single Column	Two Column	Three Column	Five Column	
C	4 $\frac{3}{8}$ "-5 $\frac{1}{8}$ "	5 $\frac{1}{2}$ "-6"	6 $\frac{1}{2}$ "-7"	8"-8 $\frac{1}{2}$ "	

Height	45"	31"-37"	22"-25"	16"-19"	12"-14"
Length of Rod	25"	21"	15 $\frac{1}{2}$ "	11"	7 $\frac{3}{4}$ "
B	21 $\frac{7}{8}$ "-24 $\frac{3}{8}$ "	17 $\frac{7}{8}$ "-20 $\frac{3}{8}$ "	12 $\frac{3}{8}$ "-14 $\frac{7}{8}$ "	7 $\frac{7}{8}$ "-10 $\frac{3}{8}$ "	4 $\frac{3}{8}$ "-7 $\frac{3}{8}$ "

Parts of No. 10 P Bracket for Princess Column Radiator

1944, 1942, 1940 Top Bracket; 1561 Wall Hanger

1941, 1943, 1945 Clip; 1642 Bottom Bracket

1525 Foot Adjusting Nut

No. 10 P. W. Adjustable Wall Bracket

For Princess Wall Radiators

Radiators up to 100 ft. have 2 No. 10 brackets, either Wall or Column.

Add 1 Bracket for each additional 50 ft.

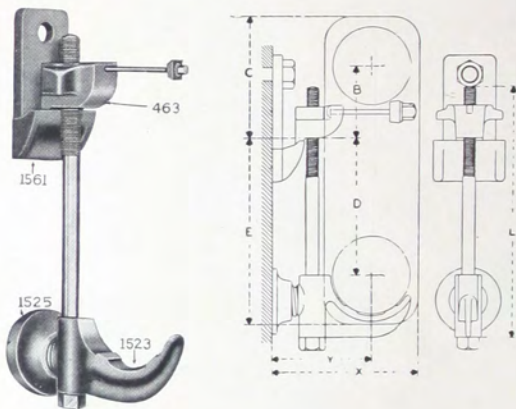

DIMENSIONS

15 in. Radiator

B— $5\frac{3}{4}$ in. to $3\frac{3}{4}$ in.

C— $7\frac{1}{4}$ in. to $5\frac{1}{4}$ in.

D— $5\frac{3}{4}$ in. to $7\frac{3}{4}$ in.

E— $7\frac{1}{4}$ in. to $9\frac{1}{4}$ in.

L—11 in.

X— $5\frac{5}{16}$ in. to $5\frac{13}{16}$ in.

Y— $3\frac{1}{4}$ in. to 4 in.

22 in. Radiator

B— $6\frac{1}{4}$ in. to $8\frac{1}{4}$ in.

C— $7\frac{3}{4}$ in. to $9\frac{3}{4}$ in.

D— $10\frac{1}{2}$ in. to $12\frac{1}{2}$ in.

E—12 in. to 14 in.

L— $16\frac{1}{4}$ in.

X— $5\frac{5}{16}$ in. to $5\frac{13}{16}$ in.

Y— $3\frac{1}{2}$ in. to 4 in.

Parts of No. 10 P. W. Princess Adjustable Wall Brackets

- 463—Bracket Hanger
- 1523—Bottom Bracket
- 1525—Foot Adjusting Nut
- 1561—Wall Hanger

Brackets and Hangers

For Princess Wall Radiators

Concealed Brackets

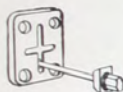

**Top Bracket
No. 3**
Use 4 No. 14
Wood Screws*

**Bottom Bracket
No. 3**
Use 4 No. 16
Wood Screws*



If Radiators are ordered "with brackets" (style or No. not specified), No. 3 will be shipped as follows:

Less than 10 rated feet of surface.....	1 bracket
10 feet of surface to and including 40 feet.....	2 brackets
Over 40 feet and including 80 feet.....	3 brackets
Over 80 feet and including 120 feet.....	4 brackets
Over 120 feet and including 160 feet.....	5 brackets



No. 1 Leg
Use 2 No. 12
Wood Screws*



**Reducible Bracket used with
Nos. 1 and 2 Bracket**

Height from floor to underside of Radiator, 12 1/2 in., can be reduced to 5 in. by cutting off the reducible bracket.



No. 2 Leg
Use 2 No. 12
Wood Screws*

No. 3 top brackets are used with Nos. 1 and 2 legs.

*Wood Screws not furnished.

Princess Adjustable Ceiling Hangers



No. 8 Ceiling Hanger
C. I. Washer 1 3/4 in. long



No. 9 Ceiling Hanger
C. I. Washer 6 in. long

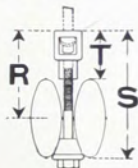

DIMENSIONS

R—3 3/16 in. to 4 3/16 in.
S—5 in. to 6 in.
T—1 3/8 in. to 2 3/8 in.
Vertical adjustment.....1 in.
Use 3/16 in. lag screws or bolts.
(Not furnished.)

Radiator Concealed Brackets

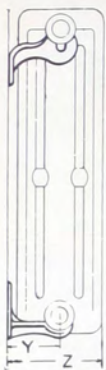

Brackets in Position

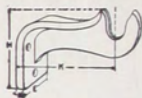
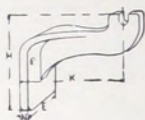

Steam Water
TOP BRACKETS

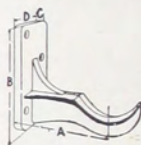

Steam or Water
BOTTOM BRACKET

For Single, Two, Three and Five-Column Princess Radiators

TOP BRACKET—STEAM AND WATER

Dimensions in Inches

Style	STEAM				WATER			
	E	H	N	K	E	H	N	K
Single-Column Princess	3½	4¾	¾	3½	3	4	¾	3½
Two-Column Princess	3½	5¼	¾	4½	3	5½	¾	4½
Three-Column Princess	3¾	5¼	¾	5½	4	5½	1½	5½
Five-Column Princess	4	5½	1½	7	4	5½	1½	7

BOTTOM BRACKET—STEAM OR WATER

Dimensions in Inches

Style	A	B	C	D	Y	Z
Single-Column Princess	3½	5½	¾	3	3½	6½
Two-Column Princess	4½	6	¾	3	4½	8
Three-Column Princess	5½	6½	1½	4	5½	10
Five-Column Princess	7	7	1½	4	7	13

Tappings

All "144" Radiators are tapped $1\frac{1}{2}$ inches at top and 2 inches at bottom, both ends. Tappings are bushed as per list below, unless otherwise ordered. When "144" radiators are ordered for special systems, specific instructions should be given as to tapping for supply, return and vent.

REGULAR TAPPING

STEAM

Two-Pipe Work

Radiators of 50 feet and smaller.....	$1'' \times \frac{3}{4}''$
Radiators larger than 50 feet and smaller than 120 feet..	$1\frac{1}{4}'' \times 1''$
Radiators of 120 feet and larger.....	$1\frac{1}{2}'' \times 1\frac{1}{4}''$
Air Valve.....	$\frac{1}{8}''$

One-Pipe Work

Radiators of 30 feet and smaller.....	$1''$
Radiators larger than 30 feet and smaller than 60 feet..	$1\frac{1}{4}''$
Radiators of 60 feet and larger, and smaller than 120 feet	$1\frac{1}{2}''$
Radiators of 120 feet and larger.....	$2''$
Air Valve.....	$\frac{1}{8}''$

WATER

Radiators of 50 feet and smaller.....	$1'' \times 1''$
Radiators larger than 50 feet and smaller than 120 feet..	$1\frac{1}{4}'' \times 1\frac{1}{4}''$
Radiators of 120 feet and larger.....	$1\frac{1}{2}'' \times 1\frac{1}{2}''$
Air Valve.....	at top $\frac{1}{8}''$

SPECIAL NOTICE

If Radiators are required tapped top and bottom same end, or top and bottom opposite ends, so specify on order.

Be sure to specify if top tapping is required.

All tappings will be made RIGHT HAND unless otherwise specified.

Princess Direct Radiators



Two-Column Princess—Water

END VIEWS

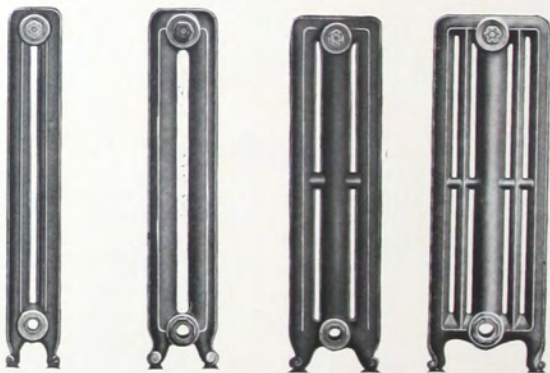

Single-Column Two-Column Three-Column Five-Column

Princess Direct Radiators



Push Nipple

MALLEABLE IRON PUSH NIPPLE CONNECTION FOR DIRECT RADIATORS

RADIATOR SECTIONS are bored or milled to gauge with a taper of $\frac{3}{8}$ of an inch to the foot.

The standard taper of wrought iron pipe threads is $\frac{3}{4}$ of an inch to the foot.

PUSH NIPPLES: The surface is crowning, lathe turned under a copious stream of lubricant, which gives a smooth "water polish"

The above, in brief, is a description of the method of producing our malleable iron push nipple connection, so long acknowledged by the trade to be **PERFECT** and **INDESTRUCTIBLE** under working conditions.

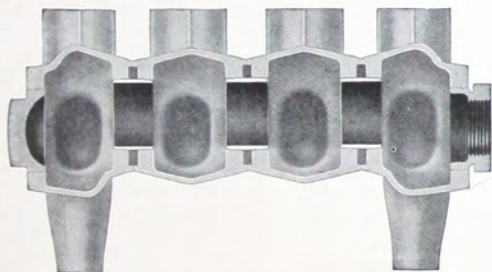

Sectional View

Princess Direct Radiators

WATER

Radiating Surface in Feet
Single-Column

Radiating Surface in Feet
Two-Column

Section	Total Length ft. - in.	HEIGHT, INCHES						HEIGHT, INCHES					
		45	37	31	25	22	19	45	37	31	25	22	19
		4½ ft. per sec.	3½ ft. per sec.	3 ft. per sec.	2½ ft. per sec.	2¼ ft. per sec.	2 ft. per sec.	5 ft. per sec.	4 ft. per sec.	3½ ft. per sec.	3 ft. per sec.	2½ ft. per sec.	2¼ ft. per sec.
3	0 - 10	13½	10½	9	7½	6¾	6	15	12	10½	9	7½	6¾
4	1 - 1	18	14	12	10	9	8	20	16	14	12	10½	9
5	1 - 4	22½	17½	15	12½	11¾	10	25	20	17½	15	13½	11¾
6	1 - 7	27	21	18	15	13½	12	30	24	21	18	15¾	13½
7	1 - 10	31½	24½	21	17½	15¾	14	35	28	24½	21	18¾	15¾
8	2 - 1	36	28	24	20	18	16	40	32	28	24	21	18
9	2 - 4	40½	31½	27	22½	20¾	18	45	36	31½	27	23¾	20¾
10	2 - 7	45	35	30	25	22½	20	50	40	35	30	26¾	22½
11	2 - 10	49½	38½	33	27½	24¾	22	55	44	38½	33	28¾	24¾
12	3 - 1	54	42	36	30	27	24	60	48	42	36	31½	27
13	3 - 4	58½	45½	39	32½	29¾	26	65	52	45½	39	34¾	29¾
14	3 - 7	63	49	42	35	31½	28	70	56	49	42	36¾	31½
15	3 - 10	67½	52½	45	37½	33¾	30	75	60	52½	45	39¾	33¾
16	4 - 1	72	56	48	40	36	32	80	64	56	48	42	36
17	4 - 4	76½	59½	51	42½	38¾	34	85	68	59½	51	44¾	38¾
18	4 - 7	81	63	54	45	40½	36	90	72	63	54	47¾	40½
19	4 - 10	85½	66½	57	47½	42¾	38	95	76	66½	57	49¾	42¾
20	5 - 1	90	70	60	50	45	40	100	80	70	60	52½	45
21	5 - 4	94½	73½	63	52½	47¾	42	105	84	73½	63	55¾	47¾
22	5 - 7	99	77	66	55	49½	44	110	88	77	66	57¾	49½
23	5 - 10	103½	80½	69	57½	51¾	46	115	92	80½	69	60¾	51¾
24	6 - 1	108	84	72	60	54	48	120	96	84	72	63	54
25	6 - 4	112½	87½	75	62½	56¾	50	125	100	87½	75	65¾	56¾
26	6 - 7	117	91	78	65	58½	52	130	104	91	78	68¾	58½
27	6 - 10	121½	94½	81	67½	60¾	54	135	108	94½	81	70¾	60¾
28	7 - 1	126	98	84	70	63	56	140	112	98	84	73½	63
29	7 - 4	130½	101½	87	72½	65¾	58	145	116	101½	87	76½	65¾
30	7 - 7	135	105	90	75	67½	60	150	120	105	90	78¾	67½

SINGLE COLUMN

A Total Height.....	45	37	31	25	22	19
H Height of Top Tapping, Princess.....	43½	34¾	28½	23	20	17

TWO COLUMN

A Total Height.....	45	37	31	25	22	19
H Height of Top Tapping, Princess.....	43	35	29	23	20	17

THREE COLUMN

A Total Height.....	45	37	31	25	22	19
H Height of Top Tapping, Princess.....	43	35	29½	23	23½	17½

FIVE COLUMN

A Total Height.....	37	25	Window Heights		
			16	14	12
H Height of Top Tapping, Princess.....	35	23	14	12	10

S = Location of air vent tapping, steam.
W = Location of air vent tapping, water.

Regular Tappings, See Page 73

Princess Direct Radiators

WATER

Radiating Surface in Feet
Three-Column

Radiating Surface in Feet
Five-Column

Sections	Total Length ft. - in.	HEIGHT, INCHES						HEIGHT, INCHES									
		45		37		31		25		22		19	37	25	16	14	12
		8 ft. per sec.	6 1/2 ft. per sec.	5 1/2 ft. per sec.	4 1/2 ft. per sec.	4 ft. per sec.	3 1/2 ft. per sec.	10 ft. per sec.	7 ft. per sec.	4 3/4 ft. per sec.	4 ft. per sec.	3 1/2 ft. per sec.	10 ft. per sec.	7 ft. per sec.	4 3/4 ft. per sec.	4 ft. per sec.	3 1/2 ft. per sec.
3	0-10 3/4	24	19 1/2	16 1/2	13 1/2	12	10 1/2	30	21	14	12	10					
4	1-2	32	26	22	18	16	14	40	28	18 3/4	16	13 1/2					
5	1-5 3/4	40	32 1/2	27 1/2	22 1/2	20	17 1/2	50	35	23 1/2	20	16 3/4					
6	1-8 1/2	48	39	33	27	24	21	60	42	28	24	20					
7	1-11 3/4	56	45 1/2	38 1/2	31 1/2	28	24 1/2	70	49	32 1/2	28	23 1/2					
8	2-3	64	52	44	36	32	28	80	56	37 1/2	32	26 3/4					
9	2-6 1/4	72	58 1/2	49 1/2	40 1/2	36	31 1/2	90	63	42	36	30					
10	2-9 1/2	80	65	55	45	40	35	100	70	46 3/4	40	33 1/2					
11	3- 3/4	88	71 1/2	60 1/2	49 1/2	44	38 1/2	110	77	51 1/2	44	36 3/4					
12	3-4	96	78	66	54	48	42	120	84	56	48	40					
13	3-7 1/4	104	84 1/2	71 1/2	58 1/2	52	45 1/2	130	91	60 3/4	52	43 1/2					
14	3-10 1/2	112	91	77	63	56	49	140	98	65 1/2	56	46 3/4					
15	4- 1 3/4	120	97 1/2	82 1/2	67 1/2	60	52 1/2	150	105	70	60	50					
16	4-5	128	104	88	72	64	56	160	112	74 3/4	64	53 1/2					
17	4-8 1/4	136	110 1/2	93 1/2	76 1/2	68	59 1/2	170	119	79 1/4	68	56 3/4					
18	4-11 1/2	144	117	99	81	72	63	180	126	84	72	60					
19	5-2 3/4	152	123 1/2	104 1/2	85 1/2	76	66 1/2	190	133	88 3/4	76	63 1/2					
20	5-6	160	130	110	90	80	70	200	140	93 1/2	80	66 3/4					
21	5-9 1/4	168	136 1/2	115 1/2	94 1/2	84	73 1/2	210	147	98	84	70					
22	6- 1/2	176	143	121	99	88	77	220	154	102 1/2	88	73 1/2					
23	6-3 3/4	184	149 1/2	126 1/2	103 1/2	92	80 1/2	230	161	107 1/2	92	76 3/4					
24	6-7	192	156	132	108	96	84	240	168	112	96	80					
25	6-10 1/4	200	162 1/2	137 1/2	112 1/2	100	87 1/2	250	175	116 3/4	100	83 1/2					
26	7- 1 1/2	208	169	143	117	104	91	260	182	121 1/2	104	86 3/4					
27	7-4 3/4	216	175 1/2	148 1/2	121 1/2	108	94 1/2	270	189	126	108	90					
28	7-8	224	182	154	126	112	98	280	196	130 3/4	112	93 1/2					
29	7-11 1/4	232	188 1/2	159 1/2	130 1/2	116	101 1/2	290	203	135 1/2	116	96 3/4					
30	8-2 1/2	240	195	165	135	120	105	300	210	140	120	100					

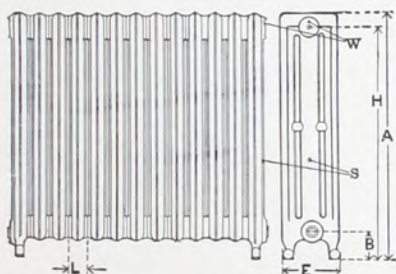

DIMENSIONS IN INCHES

Radiator Columns	Princess			Five Column	
	Single Column	Two Column	Three Column	Heights	
				37 and 25	16, 14, 12
E Width of section	5 1/4	7	9	12	12
L Length of section	3	3	3 1/4	3 1/4	3 1/4
B Height to center of regular tapping	4 3/8	4 3/8	4 3/8	4 3/8	3

Regular Tappings See Page 73

Princess Wall Radiators

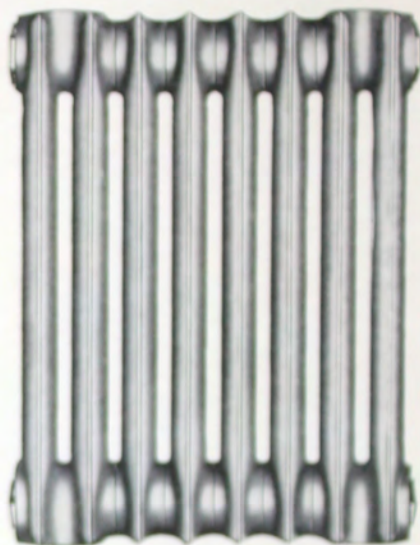

Princess Wall Radiator

Princess Wall Radiators were designed to provide a satisfactory medium for the transmission of heat when space was lacking for the installation of regular direct radiators and pipe coils. They are narrow in width and are assembled in units of varying length. By the use of specially designed brackets to hold them in place they can be readily installed wherever the need of heat and the restrictions of space dictate. In vestibules and hallways, under windows, on stairways, on columns, on ceilings, in pantries, and bathrooms, Princess Wall Radiators will transmit heat in a satisfactory, economical manner.

Princess Wall Radiators

10-Foot
Radiator



12 tubes
in length

15-Inch Height

10-Foot Radiator



8 tubes in length

22-Inch Height

25-Foot
Radiator



12 tubes
in length

37-Inch Height

2 tiers high

Princess Wall Radiators

22 INCH HEIGHT

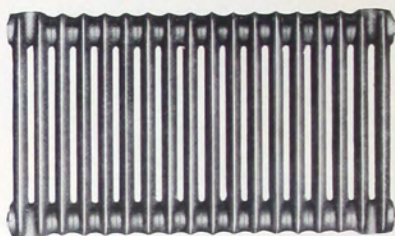

22½ Foot 22" Radiator

Length Ft. In.	Feet of Surface	Number of Groups as Shipped	Number of Tubes in each Group as Shipped	Tubes in Length
0-9	5	1	4	4
1-1	7½	1	6	6
1-5	10	1	8	8
1-9	12½	1	10	10
2-1	15	1	12	12
2-5	17½	1	14	14
2-9	20	1	16	16
3-1	22½	1	18	18
3-5	25	1	20	20
3-9	27½	1	22	22
4-1	30	1	24	24
4-5	32½	1	26	26
4-9	35	1	28	28
5-1	37½	1	30	30
5-5	40	2	16+16	32
5-9	42½	2	16+18	34
6-1	45	2	16+20	36
6-5	47½	2	20+18	38
6-9	50	2	24+16	40
7-1	52½	2	24+18	42
7-5	55	2	24+20	44
7-9	57½	2	28+18	46
8-1	60	2	24+24	48
8-5	62½	2	24+26	50
8-9	65	2	24+28	52
9-1	67½	3	20+16+18	54
9-5	70	3	16+24+16	56
9-9	72½	3	16+24+18	58
10-1	75	3	16+24+20	60

FOR ORDERING PARTS—Supply and Return End castings are either 2 tubes, 4 tubes, or 8 tubes in length. Specify on order, number of tubes and whether the nipple tappings are R. H. or L. H.

Inside castings are 8 tubes in length only.

Princess Wall Radiators

15 INCH HEIGHT



10 Foot 15" Radiator

Length Ft. In.	Feet of Surface	Number of Groups as Shipped	Number of Tubes in each Group as Shipped	Tubes in Length
1-1	5	1	6	6
1-7	7½	1	9	9
2-1	10	1	12	12
2-7	12½	1	15	15
3-1	15	1	18	18
3-7	17½	1	21	21
4-1	20	1	24	24
4-7	22½	1	27	27
5-1	25	1	30	30
5-7	27½	2	18 + 15	33
6-1	30	2	24 + 12	36
6-7	32½	2	24 + 15	39
7-1	35	2	24 + 18	42
7-7	37½	2	30 + 15	45
8-1	40	2	24 + 24	48
8-7	42½	2	24 + 27	51
9-1	45	2	24 + 30	54
9-7	47½	3	18 + 24 + 15	57
10-1	50	2	36 + 24	60
10-7	52½	3	24 + 24 + 15	63
11-1	55	3	24 + 24 + 18	66
11-7	57½	3	30 + 24 + 15	69
12-1	60	3	24 + 24 + 24	72
12-7	62½	3	24 + 24 + 27	75
13-1	65	3	24 + 24 + 30	78
13-7	67½	4	18 + 24 + 24 + 15	81
14-1	70	3	36 + 24 + 24	84
14-7	72½	4	24 + 24 + 24 + 15	87
15-1	75	4	24 + 24 + 24 + 18	90

FOR ORDERING PARTS—Supply and Return end castings are either 3 tubes, 6 tubes, or 12 tubes in length. Specify on order, number of tubes and whether the nipple tappings are R. H. or L. H.

Inside castings are 12 tubes in length only.

Princess Wall Radiators

CENTER SECTION

12 tubes
24 in. in length
10 ft. surface



SECTIONS—22 in. high are made in the following lengths.

SUPPLY OR RETURN END SECTIONS

2 tubes
4 in. in length
2½ ft. surface



4 tubes
8 in. in length
5 ft. surface



8 tubes
16 in. in length
10 ft. surface



Supply End Sections tapped L. H., Return End Sections tapped R. H. for 1¼ in. R. & L. Nipples.

CENTER SECTION

8 tubes
16 in. in length
10 ft. surface



Princess Wall Radiators

HEIGHTS—Radiators are made from Sections of two heights only, namely 15 in. and 22 in.

LENGTH—Each height (15 in. and 22 in.) can be made into one radiator (one tier high) any desired length in multiples of $2\frac{1}{2}$ ft. of surface from 5 ft. upward, i. e., 5 ft., $7\frac{1}{2}$ ft., 10 ft., $12\frac{1}{2}$ ft., 15 ft., $17\frac{1}{2}$ ft., 20 ft., $22\frac{1}{2}$ ft., 25 ft., etc.

Tubes of radiator are 2 in. center to center.

Each tube in this radiator is NOT a separate casting or SECTION.

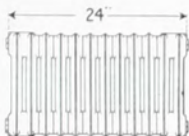

12 tubes in length

SECTIONS—15 in. HIGH are made in the following lengths.

SUPPLY OR RETURN END SECTIONS

3 tubes
6 in. in length
 $2\frac{1}{2}$ ft. surface



6 tubes
12 in. in length
5 ft. surface

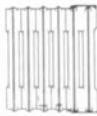

12 tubes
24 in. in length
10 ft. surface

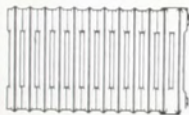

Supply End Sections tapped L. H., Return End Sections tapped R. H. for $1\frac{3}{4}$ in. R. & L. Nipples.

Princess Wall Radiators

Dimensions and Tappings

LOCATIONS OF TAPPINGS

X = Supply tapping; One-Pipe Steam.
 X, Z = Return and Supply Tappings; Water and
 Two-Pipe Steam.

W = Air vent tapping; Water.
 S = Air vent tapping; Steam.
 1 = One-Pipe work.
 2 = Two-Pipe work.

RADIATORS ONE TIER HIGH

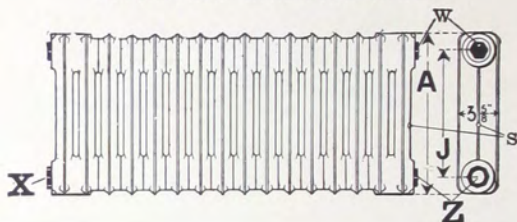

Dimensions	15-inch	22-inch
A	14 $\frac{9}{16}$ in.	21 $\frac{11}{16}$ in.
J	11 $\frac{3}{16}$ in.	18 $\frac{11}{16}$ in.

RADIATORS TWO TIERS HIGH

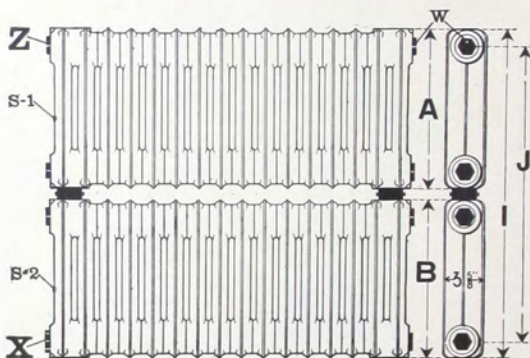

Dimensions	30-inch	37-inch	44-inch
	15 + 15	15 + 22	22 + 22
A	14 $\frac{9}{16}$ in.	14 $\frac{9}{16}$ in.	21 $\frac{11}{16}$ in.
B	14 $\frac{9}{16}$ in.	21 $\frac{11}{16}$ in.	21 $\frac{11}{16}$ in.
I	29 $\frac{7}{8}$ in.	37 in.	44 $\frac{3}{8}$ in.
J	26 $\frac{7}{8}$ in.	34 in.	41 $\frac{1}{2}$ in.

Princess Wall Radiators

RADIATORS THREE TIERS HIGH

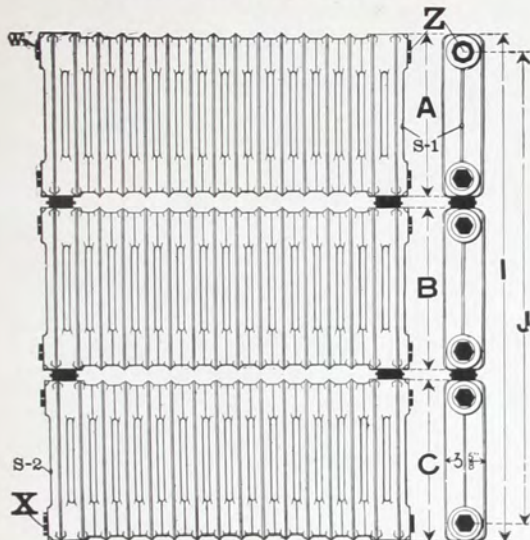

Dimensions	45-inch	52-inch	59-inch	66-inch
	15 + 15 + 15	22 + 15 + 15	22 + 22 + 15	22 + 22 + 22
A	14 $\frac{7}{8}$ in.	14 $\frac{7}{8}$ in.	14 $\frac{7}{8}$ in.	21 $\frac{1}{2}$ in.
B	14 $\frac{7}{8}$ in.	14 $\frac{7}{8}$ in.	21 $\frac{1}{2}$ in.	21 $\frac{1}{2}$ in.
C	14 $\frac{7}{8}$ in.	21 $\frac{1}{2}$ in.	21 $\frac{1}{2}$ in.	21 $\frac{1}{2}$ in.
I	45 $\frac{7}{8}$ in.	52 $\frac{7}{8}$ in.	59 $\frac{7}{8}$ in.	66 $\frac{7}{8}$ in.
J	42 $\frac{7}{8}$ in.	49 $\frac{7}{8}$ in.	56 $\frac{7}{8}$ in.	63 $\frac{7}{8}$ in.

REGULAR TAPPINGS — STEAM, Two-Pipe Work

Radiators of 50 feet and smaller	1 in. x $\frac{3}{4}$ in.
Radiators larger than 50 feet and smaller than 120 feet	1 $\frac{1}{4}$ in. x 1 in.
Radiators of 120 feet and larger	1 $\frac{1}{2}$ in. x 1 $\frac{1}{4}$ in.
Air Valve	$\frac{1}{8}$ in.

Radiators 1 tier high—tapped bottom, opposite ends.

Radiators 2, 4, or 6 tiers high—tapped top and bottom, same end.

Radiators 3, 5, or 7 tiers high—tapped top and bottom opposite ends.

STEAM, One-Pipe Work

Radiators of 30 feet and smaller	1 in.
Radiators larger than 30 feet and smaller than 60 feet	1 $\frac{1}{4}$ in.
Radiators of 60 feet and larger	1 $\frac{1}{2}$ in.
Air valve	$\frac{1}{8}$ in.

All Radiators—tapped bottom, one end.

Radiators will be tapped for two-pipe work unless otherwise specified.

WATER

Radiators of 50 feet and smaller	1 in. x 1 in.
Radiators larger than 50 feet and smaller than 120 feet	1 $\frac{1}{4}$ in. x 1 $\frac{1}{4}$ in.
Radiators 120 feet and larger	1 $\frac{1}{2}$ in. x 1 $\frac{1}{2}$ in.
Air valve—in top plug	$\frac{1}{8}$ in.

Radiators 1 tier high—tapped bottom, opposite ends.

Radiators 2, 4 or 6 tiers high—tapped top and bottom, same end.

Radiators 3, 5 or 7 tiers high—tapped top and bottom, opposite ends.

Princess Wall Radiators

R. and L. 1 3/4-in. Plugs (1086 L. and 1086 R.) in position. For assembling Groups in STEAM Radiators, Top only.

R. and L. 1 3/4-in. Nipples (476) in position. For assembling Groups in STEAM Radiators, bottom only.

For assembling Groups in WATER Radiators, top and bottom.

Disk (575) and R. and L. 1 1/2-in. Octagon Nipple (576) in position. For assembling tiers when Radiator is more than one tier high. For Steam and Water.



Three Tiers High



Two Tiers High



Steam



Water



WRENCH NO. 474.

For assembling Groups, used with Nipples 476



WRENCH NO. 45. For assembling Tiers, used with Nipples 576

ADJUSTABLE WEDGE

Use adjustable wedge between tiers when Radiators exceed 7 feet in length.

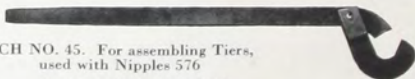

Princess Wall Radiators

LIST OF SIZES (Arranged According to Length)

Height in Tiers	One Tier High		Two Tiers High			Three Tiers High			
	15-in.	22-in.	30-in.	37-in.	44-in.	45-in.	52-in.	59-in.	66-in.
Radiator	15-in.	22-in.	30-in.	37-in.	44-in.	45-in.	52-in.	59-in.	66-in.
Actual Height Radiator Inches	14 $\frac{3}{4}$	21 $\frac{1}{4}$	29 $\frac{3}{8}$	37	44 $\frac{1}{8}$	45 $\frac{3}{16}$	59 $\frac{1}{16}$	52 $\frac{5}{16}$	66 $\frac{5}{16}$
Height of Each Tier	15	22	15 + 15	15 + 22	22 + 22	15 + 15 + 15	22 + 51 + 15	22 + 22 + 15	22 + 22 + 22
Total Length Ft.-In.	Feet of Sf'ce	Feet of Sf'ce	Feet of Sf'ce	Feet of Sf'ce	Feet of Sf'ce	Feet of Sf'ce	Feet of Sf'ce	Feet of Sf'ce	Feet of Sf'ce
	G	G	G	G	G	G	G	G	G
0-9	. 1	5 1	.	.	10 2	.	.	.	15 3
1-1	5 1	7 $\frac{1}{2}$ 1	10 2	12 $\frac{1}{2}$ 2	15 2	15 3	17 $\frac{1}{2}$ 3	20 3	22 $\frac{1}{2}$ 3
1-5	.	10 1	.	.	20 2	.	.	.	30 3
1-7	7 $\frac{1}{2}$ 1	.	15 2	.	.	22 $\frac{1}{2}$ 3	.	.	.
1-9	.	12 $\frac{1}{2}$ 1	.	.	25 2	.	.	.	37 $\frac{1}{2}$ 3
2-1	10 1	15 1	20 2	25 2	30 2	30 3	35 3	40 3	45 3
2-5	.	17 $\frac{1}{2}$ 1	.	.	35 2	.	.	.	52 $\frac{1}{2}$ 3
2-7	12 $\frac{1}{2}$ 1	.	25 2	.	.	37 $\frac{1}{2}$ 3	.	.	.
2-9	.	20 1	.	.	40 2	.	.	.	60 3
3-1	15 1	22 $\frac{1}{2}$ 1	30 2	37 $\frac{1}{2}$ 2	45 2	45 3	52 $\frac{1}{2}$ 3	60 3	67 $\frac{1}{2}$ 3
3-5	.	25 1	.	.	50 2	.	.	.	75 3
3-7	17 $\frac{1}{2}$ 1	.	35 2	.	.	52 $\frac{1}{2}$ 3	.	.	.
3-9	.	27 $\frac{1}{2}$ 1	.	.	55 2	.	.	.	82 $\frac{1}{2}$ 3
4-1	20 1	30 1	40 2	50 2	60 2	60 3	70 3	80 3	90 3
4-5	.	32 $\frac{1}{2}$ 1	.	.	65 2	.	.	.	97 $\frac{1}{2}$ 3
4-7	22 $\frac{1}{2}$ 1	.	45 2	.	.	67 $\frac{1}{2}$ 3	.	.	.
4-9	.	35 1	.	.	70 2	.	.	.	105 3
5-1	25 1	37 $\frac{1}{2}$ 1	50 2	62 $\frac{1}{2}$ 2	75 2	75 3	87 $\frac{1}{2}$ 3	100 3	112 $\frac{1}{2}$ 3
5-5	.	40 2	.	.	80 4	.	.	.	120 6
5-7	27 $\frac{1}{2}$ 2	.	55 4	.	.	82 $\frac{1}{2}$ 6	.	.	.
5-9	.	42 $\frac{1}{2}$ 2	.	.	85 4	.	.	.	127 $\frac{1}{2}$ 6
6-1	30 2	45 2	60 4	75 4	90 4	90 6	105 6	120 6	135 6
6-5	.	47 $\frac{1}{2}$ 2	.	.	95 4	.	.	.	142 $\frac{1}{2}$ 6
6-7	32 $\frac{1}{2}$ 2	.	65 4	.	.	97 $\frac{1}{2}$ 6	.	.	.
6-9	.	50 2	.	.	100 4	.	.	.	150 6
7-1	35 2	52 $\frac{1}{2}$ 2	70 4	87 $\frac{1}{2}$ 4	105 4	105 6	122 $\frac{1}{2}$ 6	140 6	157 $\frac{1}{2}$ 6
7-5	.	55 2	.	.	110 4	.	.	.	165 6
7-7	37 $\frac{1}{2}$ 2	.	75 4	.	.	112 $\frac{1}{2}$ 6	.	.	.
7-9	.	57 $\frac{1}{2}$ 2	.	.	115 4	.	.	.	172 $\frac{1}{2}$ 6
8-1	40 2	60 2	80 4	100 4	120 4	120 6	140 6	160 6	180 6
8-5	.	62 $\frac{1}{2}$ 2	.	.	125 4	.	.	.	187 $\frac{1}{2}$ 6
8-7	42 $\frac{1}{2}$ 2	.	85 4	.	.	127 $\frac{1}{2}$ 6	.	.	.
8-9	.	65 2	.	.	130 4	.	.	.	195 6
9-1	45 2	67 $\frac{1}{2}$ 2	90 4	112 $\frac{1}{2}$ 5	135 6	135 6	157 $\frac{1}{2}$ 7	180 8	202 $\frac{1}{2}$ 9
9-5	.	70 3	.	.	140 6	.	.	.	210 9
9-7	47 $\frac{1}{2}$ 3	.	95 6	.	.	142 $\frac{1}{2}$ 9	.	.	.
9-9	.	72 $\frac{1}{2}$ 3	.	.	145 6	.	.	.	217 $\frac{1}{2}$ 9
10-1	50 2	75 3	100 4	125 5	150 6	150 6	175 7	200 8	225 9

G = Number of Groups in Radiator as shipped.

Princess Wall Radiators

LIST OF SIZES (Arranged According to Surface)

LIST OF SIZES (Arranged According to Surface)

Radiator Actual Height of Radiator Height of each Tier Feet of Surface	ONE TIER HIGH			TWO TIERS HIGH			THREE TIERS HIGH			66-inch						
	15-inch 14 $\frac{1}{2}$ -in. 13 in.	22-inch 21 $\frac{1}{2}$ -in. 22 in.	30-inch 29 $\frac{1}{2}$ -in. 15+15	37-inch 37 in. 22+15	44-inch 44 $\frac{1}{2}$ -in. 22+22	45-inch 45 $\frac{1}{2}$ -in. 15+15+15	52-inch 52 $\frac{1}{2}$ -in. 22+15+15	59-inch 59 $\frac{1}{2}$ -in. 22+22+15	66-inch 66 $\frac{1}{2}$ -in. 22+22+22	No. of Tubes	Length ft.-in.	No. of Tubes	Length ft.-in.	No. of Tubes	Length ft.-in.	No. of Tubes
5	6	1-1	4	0-9	12	2-1	18	3-1	24	4-1	30	5-1	36	6-1	42	7-1
7 $\frac{1}{2}$	9	1-1	6	1-1	9	1-7	12	2-1	15	2-7	21	3-7	27	4-7	33	5-7
10	12	2-1	8	1-5	12	2-1	18	3-1	24	4-1	30	5-1	36	6-1	42	7-1
12 $\frac{1}{2}$	15	2-7	10	1-9	15	2-7	21	3-7	27	4-7	33	5-7	39	6-7	45	7-7
15	18	3-1	12	2-1	18	3-1	24	4-1	30	5-1	36	6-1	42	7-1	48	8-1
17 $\frac{1}{2}$	21	3-7	14	2-5	21	4-1	27	4-7	33	5-7	39	6-7	45	7-7	51	8-7
20	24	4-1	16	2-9	24	5-1	30	6-1	36	7-1	42	8-1	48	9-1	54	9-1
22 $\frac{1}{2}$	27	4-7	18	3-3	27	5-7	36	8-1	42	9-1	48	10-1	54	11-1	60	12-1
25	30	5-1	20	3-5	30	6-1	40	6-9	48	7-9	56	8-9	64	9-9	72	10-9
27 $\frac{1}{2}$	33	5-7	22	3-9	33	6-7	42	7-1	51	8-1	59	9-1	67	10-1	75	11-1
30	36	6-1	24	4-1	36	7-1	44	7-5	54	8-5	62	9-5	70	10-5	78	11-5
32 $\frac{1}{2}$	39	6-7	26	4-5	42	8-1	46	7-9	54	8-9	62	9-9	70	10-9	78	11-9
35	42	7-1	28	4-9	45	8-1	48	8-1	57	9-1	66	10-1	74	11-1	81	12-1
37 $\frac{1}{2}$	45	7-7	30	5-1	48	8-7	51	8-5	60	10-1	70	11-1	78	12-1	86	13-1
40	48	8-1	32	5-5	51	8-7	54	8-9	63	10-7	72	11-7	80	12-7	88	13-7
42 $\frac{1}{2}$	51	8-7	34	5-9	54	9-1	57	9-5	66	11-1	74	12-1	82	13-1	90	14-1
45	54	9-1	36	6-1	57	9-7	60	10-1	69	11-7	78	12-7	86	13-7	94	14-7
47 $\frac{1}{2}$	57	9-7	38	6-5	60	10-1	63	10-7	72	12-1	81	13-1	90	14-1	99	15-1
50	60	10-1	40	6-9	63	10-7	66	11-1	75	12-7	84	13-7	93	14-7	102	15-7
52 $\frac{1}{2}$	63	10-7	42	7-1	66	11-1	69	11-7	78	13-1	87	14-1	96	15-1	105	16-1
55	66	11-1	44	7-5	69	11-7	72	12-1	81	13-7	90	14-7	99	15-7	108	16-7
57 $\frac{1}{2}$	69	11-7	46	7-9	72	12-1	75	12-7	84	14-1	93	15-1	102	16-1	111	17-1
60	72	12-1	48	8-1	75	12-7	78	13-1	87	14-7	96	15-7	105	16-7	114	17-7
62 $\frac{1}{2}$	75	12-7	50	8-5	78	13-1	81	13-7	90	15-1	99	16-1	108	17-1	117	17-7
65	78	13-1	52	8-9	81	13-7	84	14-1	93	15-7	102	16-7	111	17-7	120	18-1
67 $\frac{1}{2}$	81	13-7	54	9-1	84	14-1	87	14-7	96	16-1	105	17-1	114	18-1	123	18-7
70	84	14-1	56	9-5	87	14-7	90	15-1	99	16-7	108	17-7	117	18-7	126	19-1
72 $\frac{1}{2}$	87	14-7	58	9-9	90	15-1	93	15-7	102	17-1	111	18-1	120	19-1	129	19-7
75	90	15-1	60	10-1	93	15-7	96	16-1	105	18-1	114	19-1	123	20-1	132	20-7
77 $\frac{1}{2}$	93	15-7	62	10-5	96	16-1	99	16-7	108	18-7	117	19-7	126	20-7	135	21-1

For Number of Groups in Radiator as shipped, see Page 87

Princess Wall Radiators

(LIST OF SIZES Arranged According to Surface)

LIST OF SIZES (Arranged According to Surface)

Radiator Actual Height of Radiator Height of each Tier Feet of Surface	ONE TIER HIGH			TWO TIERS HIGH			THREE TIERS HIGH			66-inch			
	15-inch	22-inch	30-inch	37-inch	44-inch	45-inch	52-inch	59-inch	66-inch				
	14 3/8 in. 15 in. Length No. of Tubes ft.-in.	21 1/8 in. 22 in. Length No. of Tubes ft.-in.	29 7/8 in. 15+15 Length No. of Tubes ft.-in.	37 in. 22+15 Length No. of Tubes ft.-in.	44 3/8 in. 22+22 Length No. of Tubes ft.-in.	45 3/8 in. 15+15+15 Length No. of Tubes ft.-in.	52 3/8 in. 22+15+15 Length No. of Tubes ft.-in.	59 3/8 in. 22+22+15 Length No. of Tubes ft.-in.	66-inch 66 3/8 in. Length No. of Tubes ft.-in.				
80	96	10-1	48	8-1	32	5-5	33	5-7	30	5-1	22	3-9	80
82 1/2	99	10-7	66	11-1	34	5-9	33	5-7	30	5-1	22	3-9	82 1/2
85	102	11-1	68	11-5	34	5-9	34	5-7	30	5-1	22	3-9	85
87 1/2	105	11-7	70	11-9	42	7-1	36	6-1	30	5-1	24	4-1	87 1/2
90	108	12-1	72	12-1	54	9-1	36	6-1	30	5-1	24	4-1	90
95	112	12-7	77	12-7	38	6-5	39	6-7	30	5-1	26	4-5	95
97 1/2	115	13-1	80	13-1	40	6-9	40	6-9	30	5-1	26	4-5	97 1/2
100	118	13-7	83	13-7	42	7-1	42	7-1	36	6-1	28	4-9	100
105	122	14-1	86	14-1	44	7-5	44	7-5	36	6-1	28	4-9	105
110	126	14-7	89	14-7	54	9-1	45	7-7	42	7-1	30	5-1	110
112 1/2	129	15-1	91	15-1	46	7-9	46	7-9	42	7-1	30	5-1	112 1/2
115	132	15-7	94	15-7	48	8-1	48	8-1	42	7-1	32	5-5	115
120	137	16-1	99	16-1	50	8-5	50	8-5	48	8-1	32	5-5	120
122 1/2	140	16-7	102	16-7	60	10-1	51	8-7	48	8-1	34	5-9	122 1/2
125	143	17-1	105	17-1	52	8-9	52	8-9	48	8-1	34	5-9	125
127 1/2	146	17-7	108	17-7	54	9-1	54	9-1	48	8-1	35	6-1	127 1/2
130	149	18-1	111	18-1	56	9-5	56	9-5	48	8-1	35	6-1	130
135	153	18-7	114	18-7	66	11-1	57	9-7	42	7-1	38	6-5	135
137 1/2	156	19-1	117	19-1	58	9-9	58	9-9	42	7-1	38	6-5	137 1/2
140	159	19-7	120	19-7	60	10-1	60	10-1	54	9-1	40	6-9	140
142 1/2	162	20-1	123	20-1	72	12-1	63	10-7	54	9-1	42	7-1	142 1/2
145	165	20-7	126	20-7	66	11-1	66	11-1	60	10-1	44	7-5	145
150	170	21-1	130	21-1	56	9-5	56	9-5	60	10-1	44	7-5	150
155	175	21-7	134	21-7	60	10-1	60	10-1	66	11-1	46	7-9	155
157 1/2	178	22-1	137	22-1	72	12-1	72	12-1	60	10-1	48	8-1	157 1/2
160	181	22-7	140	22-7	66	11-1	66	11-1	66	11-1	46	7-9	160
165	186	23-1	144	23-1	69	11-7	69	11-7	72	12-1	48	8-1	165
172 1/2	193	23-7	149	23-7	72	12-1	72	12-1	72	12-1	54	9-1	172 1/2
175	196	24-1	152	24-1	60	10-1	60	10-1	60	10-1	48	8-1	175
180	201	24-7	156	24-7	66	11-1	66	11-1	66	11-1	48	8-1	180

For Number Groups in Radiator as shipped, See Page 87

X-Ray

Plate Warmer or Pantry Radiator



STEAM OR WATER
Assembled with 8 Foot Sections

Dimensions in Inches

Number of Sections High	Feet of Surface	Total Height	Total Length	Total Width
1	8	8	21 $\frac{3}{4}$	14 $\frac{5}{16}$
2	17	18	21 $\frac{3}{4}$	14 $\frac{5}{16}$
3	26	28	21 $\frac{3}{4}$	14 $\frac{5}{16}$
4	35	38	21 $\frac{3}{4}$	14 $\frac{5}{16}$
5	44	48	21 $\frac{3}{4}$	14 $\frac{5}{16}$

Shipped made up unless otherwise ordered.
Specify required tapping.

Indirect Radiators

Gold Pin

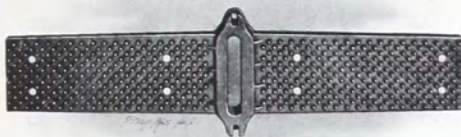

Steam Only—Intermediate Section
REGULAR PATTERN
10 Feet per Section



Steam or Water—Intermediate Section
10-INCH FLANGE
15 Feet per Section

DIMENSIONS

Radiators	Regular Pattern	Ten Inch Flange
Distance from Center to Center..... in.	3 $\frac{1}{4}$	3 $\frac{1}{4}$
Free Air Space, per Section..... sq. in.	41	38
Distance between Ends of Pins..... in.	$\frac{1}{4}$	$\frac{1}{4}$
Length of Pin..... in.	$\frac{3}{4}$	$\frac{3}{4}$
Height of Flange..... in.	10 $\frac{3}{4}$	14 $\frac{3}{4}$
Length of Section..... in.	40 $\frac{1}{2}$	40 $\frac{1}{2}$
Height of Section..... in.	7 $\frac{1}{4}$	10 $\frac{3}{4}$

REGULAR TAPPINGS

Supply..... 1 $\frac{1}{4}$ in.	REGULAR PATTERN GOLD PIN Air Valve..... $\frac{3}{8}$ in.	Return..... 1 $\frac{1}{4}$ in.
Supply..... 1 $\frac{1}{2}$ in.	TEN INCH FLANGE GOLD PIN Air Valve..... $\frac{3}{8}$ in.	Return..... 1 $\frac{1}{2}$ in.

Indirect Radiators

TWELVE-FOOT R. AND L. NIPPLE GOLD PIN

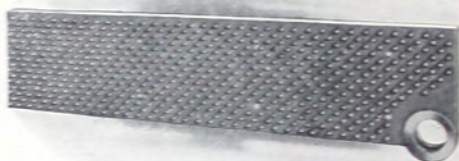

Intermediate Section
Steam Only
12 Feet per Section

DIMENSIONS

Distance from Center to Center.....	3¼ in.
Free Air Space, per Section.....	36 sq. in.
Distance between Ends of Pins.....	¼ in.
Length of Pin.....	¾ in.
Height of Section.....	9 in.
Length of Section.....	36 in.
Size of R. & L. Nipple.....	2 in.

REGULAR TAPPING

Supply.....1½ in. Air Valve.....¾ in. Return.....1½ in.
Supply or Head Section is tapped L. H. for R. and L. Nipple.
Return or Drain Section is tapped R. H. for R. and L. Nipple.

Indirect Radiators

R. AND L. NIPPLE GOLD PIN



15 Foot R. and L. Nipple Gold Pin



20 Foot R. and L. Nipple Gold Pin
Intermediate Sections
Steam or Water

DIMENSIONS

Radiators	15 Feet	20 Feet
Distance from Center to Center..... in.	3 $\frac{1}{4}$	3 $\frac{1}{4}$
Free Air Space, per Section..... sq. in.	36	36
Distance between Ends of Pins..... in.	$\frac{1}{4}$	$\frac{1}{4}$
Length of Pin..... in.	$\frac{3}{4}$	$\frac{3}{4}$
Length of Section..... in.	36	36
Height of Section..... in.	11 $\frac{1}{2}$	15 $\frac{1}{2}$
Size of R. and L. Nipple..... in.	2	2

REGULAR TAPPINGS

Supply..... 2 in. Air Valve..... $\frac{3}{8}$ in. Return..... 2 in.
 Supply or Head Section is tapped L. H. for R. and L. Nipple.
 Return or Drain Section is tapped R. H. for R. and L. Nipple.

Indirect Radiators

SCHOOL PIN



15 Foot School Pin



20 Foot School Pin
Supply and Return End Sections
Steam or Water

DIMENSIONS

Radiators	15 Feet	20 Feet
Distance from Center to Center..... in.	4	4
Free Air Space, per Section..... sq. in.	61	61
Distance between Ends of Pins..... in.	$\frac{1}{2}$	$\frac{1}{2}$
Length of Pin..... in.	1	1
Length of Section..... in.	36	36
Height of Section..... in.	$11\frac{1}{2}$	$15\frac{1}{2}$
Size of R. and L. Nipple..... in.	2	2

REGULAR TAPPING

Supply..... 2 in. Air Valve..... $\frac{3}{8}$ in. Return..... 2 in.
 Supply or Head Section is tapped L. H. for R. and L. Nipple.
 Return or Drain Section is tapped R. H. for R. and L. Nipple.

Indirect Radiators

HORIZONTAL AERIAL



15 Foot Aerial

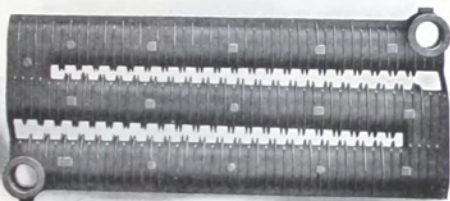

Intermediate Sections
Steam or Water

DIMENSIONS IN INCHES

Radiators	15 Feet	20 Feet
Distance between Center of Sections.....	3½"	3½"
Free Air Space, per Section.....	61 sq. in.	65 sq. in.
Distance between Body of Sections.....	1½"	1½"
Length of Extended Surface.....	15"	15"
Height of Section.....	11"	15½"
Length of Section.....	37"	36¾"
Size of R. and L. Nipple.....	2"	2"

REGULAR TAPPING

Supply..... 2" R. H. Air Valve..... 3/8" Return..... 2" L. H.
 When Radiators are ordered tapped smaller than the above (2")
 the female threads in bushings will be R. H.

Radiator Valves and Elbows

Angle Steam Radiator Valve with Union



Size	1/2"	3/4"	1"	1 1/4"	1 1/2"	2"
List*	3.70	4.30	5.10	6.40	8.40	13.60

Angle Water Radiator Valve with Union



Size	1/2"	3/4"	1"	1 1/4"	1 1/2"	2"
List*	3.25	3.70	4.50	5.75	7.30	12.00

*Rough Body and polished trimmings, plated all over.

Radiator Gate Valve with Union

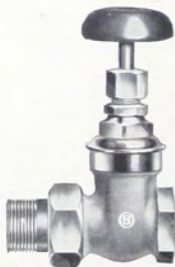

Size	1/2"	3/4"	1"	1 1/4"	1 1/2"	2"
List*	3.65	4.25	5.20	6.60	9.00	12.80

Radiator Elbow



Size	1/2"	3/4"	1"	1 1/4"	1 1/2"	2"
List*	1.75	2.00	2.50	3.30	4.25	7.20

*Rough Body and polished trimmings, plated all over.

Air Valves

HOFFMAN VENTING VALVES

Hoffman Valves are automatic, non-adjustable and are guaranteed to properly function for a period of five years from date of installation.



No. 1 Hoffman Siphon Air Valve with $\frac{1}{8}$ " connection.
List price.....\$1.90



No. 2 Hoffman Siphon Air and Vacuum Valve with $\frac{1}{8}$ " connection.
List price.....\$4.50

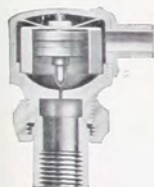

No. 3 Hoffman Air Line Valve, radiator connection, $\frac{1}{8}$ " male, with $\frac{1}{4}$ " air line connection.
List price.....\$2.50



No. 4 Hoffman Quick Vent Air Valve, standard connection, $\frac{3}{4}$ ", can also be supplied with $\frac{1}{4}$ " connection. List price.....\$2.80



No. 5 Hoffman Quick Vent Float Air Valve, $\frac{3}{8}$ " pipe connection; furnished with $\frac{3}{16}$ " port for pressure below 3 lbs., $\frac{1}{6}$ " port for 3 lbs. or over. List price.....\$8.00



No. 6 Hoffman Quick Vent Float Air and Vacuum Valve, pipe connection $\frac{3}{8}$ "; vent port for less than 3 lbs. is $\frac{3}{16}$ "; for 3 lbs. and over use $\frac{1}{6}$ " port. List price.....\$12.00

Quotations on other Hoffman Specialties and Combinations on Application.

Air Valves

DOLE

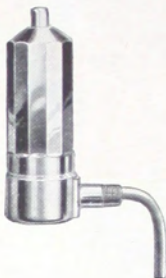

No. 1.....	\$1.50
No. 2B Vac.....	4.00
No. 6B Vac.....	5.00
Quick Vent No. 3A.....	1.90
Quick Vent No. 3B.....	1.90
Quick Vent No. 3C.....	2.40

CADWELL

Automatic Air Valve



No. 10.....	\$1.00
Quick Vent.....	1.25

**NON-ADJUSTABLE-FLUID
CONTROL**

Air Valves

WARCO



“WARCO” No. 1
 $\frac{1}{8}$ " Side Outlet Air
Valve—for Radiators.



WARCO No. 4

No. 1	\$1.50
No. 2	4.50
No. 3 Reg.	2.70
No. 3 Vac.	5.70
No. 4	3.65
No. 5	10.00
No. 6	14.00

Vacuum Valve . . . \$2.50

Vac. Quick Vent. . . 3.00

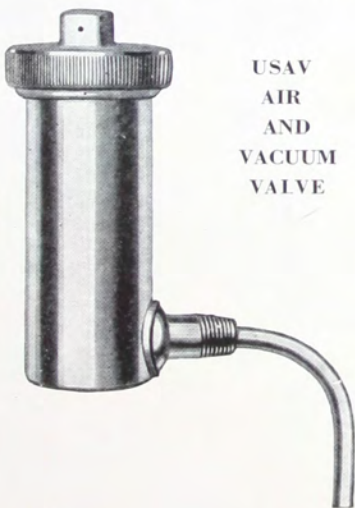

USAV
AIR
AND
VACUUM
VALVE

Air Valves

The Invisible In-AIRID

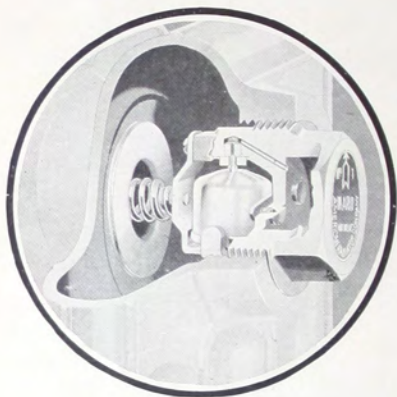

No. 1
\$1.85

No. 2
\$3.00

COMPRESSION AIR VALVES



Key Type
3/8" Connection
List price.....\$0.16



Wood Wheel Type
3/8" Connection
List price.....\$0.20



Key
List price, . . . \$0.05

BRECKENRIDGE AIR VALVES

for Indirect Radiators

Cast Iron, Finished Black
3/8" Connection



**No. 1
Breckenridge
Air Valve**
List price . . . \$1.40



**No. 2
Breckenridge
Air Valve**
List price . . . \$1.60

“Holyoke”

AUXILIARY WATER HEATERS

Size	Capacity, Gallons		Length	Diameter	Width	Depth
	Below Water Level	With Live Steam				
Special A-4	30*	52†	9 $\frac{3}{4}$ "		6 $\frac{1}{4}$ "	5 $\frac{3}{8}$ "
A-4	30*	52†	9 $\frac{3}{4}$ "		6 $\frac{1}{4}$ "	5 $\frac{3}{8}$ "
A-5	40*	75†	12 $\frac{3}{4}$ "		6 $\frac{1}{4}$ "	5 $\frac{3}{8}$ "
A-6	52*	100†	15 $\frac{3}{4}$ "		6 $\frac{1}{2}$ "	5 $\frac{3}{8}$ "
A-16	30- 52†	100**	11"	6 $\frac{1}{4}$ "		
A-24	66- 82†	150**	15 $\frac{1}{8}$ "	6 $\frac{1}{4}$ "		
A-32	100-120†	225**	19 $\frac{1}{4}$ "	6 $\frac{1}{4}$ "		

Size	Coil Connections	Shell Connections	Union Sizes	Shipping Wt., Lbs.
Special A-4	$\frac{3}{4}$ "	1"	No Union	11 $\frac{1}{2}$
A-4	$\frac{3}{4}$ "	1"	$\frac{1}{2}$ " or $\frac{3}{4}$ "	11 $\frac{1}{2}$
A-5	$\frac{3}{4}$ "	1"	$\frac{1}{2}$ " or $\frac{3}{4}$ "	15
A-6	$\frac{3}{4}$ "	1"	$\frac{1}{2}$ " or $\frac{3}{4}$ "	19
A-16	$\frac{3}{4}$ "	1"	$\frac{3}{4}$ "	35
A-24	$\frac{3}{4}$ "	1 $\frac{1}{4}$ "	$\frac{3}{4}$ "	49
A-32	1"	1 $\frac{1}{2}$ "	1"	65

*Ratings based on 100° temperature rise in three hours with steam or vapor boiler.

†Ratings based on 118° temperature rise in three hours with steam or vapor boiler.

‡Ratings based on 100° temperature rise in three hours, five pounds pressure.

**Ratings based on 118° temperature rise in three hours, five pounds pressure.

All Auxiliary Heaters with the exception of the Special A-4 are equipped with brass unions.



Domestic Taco Water Heater

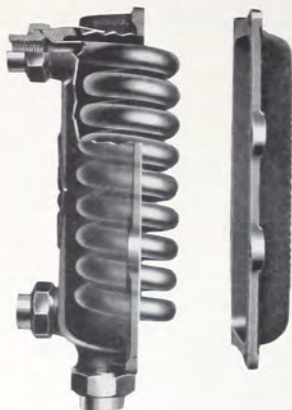

The Domestic Taco Water Heater is connected below the water line of steam or vapor boilers. The water in the heating boiler circulates through shell of Taco, transferring its heat to the domestic water which flows through the coil to the tank. The Domestic Taco Heater consists of a cast iron housing containing a one-piece coil to which it is permanently fastened and tested to 1200 pounds making positive assurance against leakage. Unions provided for quick installation. Water in contact with copper and brass (not iron) to avoid any possible discoloration. Removable cover permits of easy cleaning without disconnecting any piping.

Size	0	30	1	2	3
Capacity, below water line gal.	30	30-40	40-60	80-120	160-200
Capacity, live steam, gal.		50	75	150	300
Sq. ft. water radiation.				60	120
Height, inches.	8½	11	13	16½	21½
Diameter, inches.	5½	5½	5½	7½	8½
Tank connections, inches.	¾	¾	¾	1	1¼
Boiler connections, inches.	1	1	1	1¼	2
Shipping weight, pounds.	9	11	14	24	54
List Prices.	\$10.00	\$15.00	\$20.00	\$30.00	\$50.00

Size of H. B. Smith Co. Steam Boilers with Taco Indirect Heaters connected above the water line of Boiler				Size of Taco Heaters used below the water line of Steam Boilers		
Gals. of water heated 100°F in 1 hour	Size of Tank gallons based on usual conditions of heating in 4 hours	Size of H. B. Smith Steam Boiler	Size of Taco Indirect Heater	Gals. of water heated 100°F in 1 hour	Size of Tank gallons based on usual conditions of heating in 4 hours	Size of Taco Indirect Heater
50	200	115 H. B.	No. 2	6	25	No. 0
75	300	217 H. B.	No. 3	8	30	No. 30
100	400	219 H. B.	No. 4	15	60	No. 1
150	600	221 H. B.	No. 4	20	80	No. 2
200	800	{ 224 H. B. } or { 4-24 Mills } { 227 H. B. }	No. 5	40	160	No. 3
250	1000	{ 5-24 Mills } or { 7-24 Mills }	No. 5	80	320	No. 4
400	1600	{ 5-27 Smith } or { 9-24 Mills }	No. 6	160	640	No. 5
500	2000	{ 7-27 Smith }	2-No. 5	240	960	No. 6

Data and prices on Bronze, Semi-Indirect Universal, Flow Line, Tank Coil and Automatic Tacos or Taco Water Mixer can be furnished on application.

Apartment Taco Water Heaters

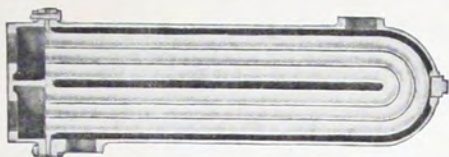

Designed primarily for use with live steam wherever constant steam supply is available. Used for heating domestic water or heating hot water radiators. Can also be used below water line of steam heating boilers. Installed in a horizontal position—consists of cast iron housing containing a series of copper "U" tubes through which the domestic water circulates.

Size	4	5	6
Capacity, below Water Line, gallons.....	320	640	960
Capacity, Live Steam, gallons.....	600	1200	1800
Sq. ft. Water Radiation.....	240	480	750
Height, inches.....	26*	38*	40*
Diameter, inches.....	8	11 $\frac{3}{4}$	13 $\frac{1}{2}$
Tank connections, inches.....	2	2 $\frac{1}{2}$	3
Boiler Connections, inches.....	2	2 $\frac{1}{2}$	3
Shipping Weight, pounds.....	96	192	265
List Prices.....	\$100.00	\$200.00	\$300.00

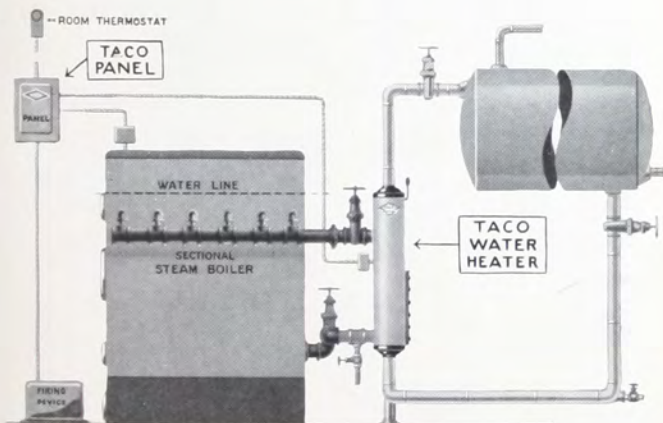

Capacity based on 100-degree temperature rise in three hours. Increase size Taco for inadequate tank capacity.

Domestic Taco with Brass unions shipped unless old type is specified.

*Length.

Super Taco Jacketed

Size	7	8	9	10	12	15
Capacity, gallons.....	160	220	320	450	600	800
Boiler Connections, inches.....	2	2	2½	2½	3	3
Tank Connections, inches.....	1½	1½	2	2	2	2
Shipping Weight, pounds.....	70	100	130	150	185	220
List Price.....	\$55	\$70	\$90	\$110	\$150	\$190

Size	20	25	35	50	75	100
Capacity, gallons.....	1000	1250	1750	2500	3750	5000
Boiler Connections, inches.....	4	4	4	5	5	6
Tank Connections, inches.....	2½	2½	4	4	5	6
Shipping Weight, pounds.....	280	350	500	685	1050	1250
List Price.....	\$270	\$330	\$470	\$670	\$1000	\$1300

Capacity based on 100-degree temperature rise in three hours. Increase size of Taco for inadequate tank capacity.

Thirty-gallon tank capacity is usually required per family.

Universal Heaters

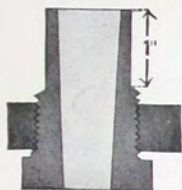

Fig. 1. For use in Round Hot Water Heating Boilers. Better than a pipe coil. Fits in the fire pot. Interferes with fire less, and there are no screwed connections to burn out. Fits any make round boiler. 3—1 inch connections on back, 1 on bottom. Made in both Brass and Malleable Iron.

No.	Capacity Gallons	Shipping Weight Lbs.	List Price
6-9-30 Iron.....	30	10	\$8.00
6-9-60 Iron.....	60	17	14.00
6-9-30 Brass.....	30	10	20.00
6-9-60 Brass.....	60	17	35.00

Fusible Plugs, Draw-Off Cocks and Water Relief Valves

FUSIBLE PLUG



Long Pattern $\frac{1}{2}$ "

List price.....\$1.20

DRAW-OFF COCK



List Price

$\frac{3}{4}$ ".....\$1.75

WATER RELIEF VALVES

List Prices

Size	$\frac{1}{2}$ "	$\frac{3}{4}$ "	1"	1 $\frac{1}{4}$ "	1 $\frac{1}{2}$ "	2"
Semi-Finishes	\$10.00	\$10.00	\$12.00	\$15.00	\$18.00	\$27.00

When ordering state pressure at which valves are to be set to relieve.

EXPANSION TANKS



Expansion Tank Trimmings

Size Inches	Cap. Gal.	Feet Rad'n	List Price	List Price Gauge Fitt.
10 x 20	8	250	\$7.50	\$1.75
12 x 20	10	300	8.00	1.75
12 x 30	15	500	9.00	1.75
14 x 30	20	700	12.50	1.75
16 x 30	26	950	14.00	1.75
16 x 36	32	1300	15.00	1.75
16 x 48	42	2000	16.50	1.75



Expansion Tank

Thermometers and Altitude Gauges



**Straight
Thermometer**
List price, \$5.00



**Angle
Thermometer 1/2"**
List price, \$6.00



Altitude Gauge
4 1/2"
List price, \$8.00



**Combination
Alti-Thermo
Gauge**
List Prices
3 1/2" \$12.00
4 1/2" \$15.00

NO. 10 FLOOR AND CEILING PLATES



View Closed



View Open

Size	1/2"	3/4"	1"	1 1/4"	1 1/2"	2"	2 1/2"	3"	3 1/2"	4"
List Price*	\$0.27	\$0.28	\$0.32	\$0.35	\$0.38	\$0.45	\$0.65	\$0.80	\$1.00	\$1.25

*Nickel Plated

Steam Gauges and Safety Valves

Steam Gauge



List Prices

3½"	\$7.00
4½"	8.00
8½"	22.00

Retard Gauge



List Prices

3½"	\$8.00
4½"	10.00
8½"	25.00

¼" Brass Syphon, List	\$1.00
¼" Steam Gauge Cock, List	.75

POLICE VALVE

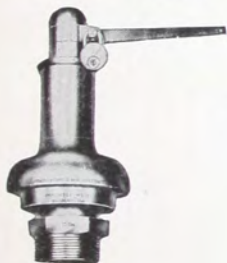

FLAT SEAT VALVES

Size	2"	2½"	3"	3½"	4"
List Price	\$30.00	\$50.00	\$65.00	\$80.00	\$100.00
Grate Area Sq. Ft.	11	17½	24¾	33½	44

REGULAR POP SAFETY VALVE



Size	1"	1¼"	1½"	2"
List	\$6.00	\$6.75	\$8.25	\$11.25
Size	2½"	3"	3½"	4"
List	\$26.00	\$37.50	\$50.00	\$80.00

Steam Gauges—Compound: 3½", \$2.80 net; 4½", \$3.10 net; 8½", \$14.50 net.

"Tork Draft Opener"

the only 10-day heater clock

For Any Coal Heater \$10.00

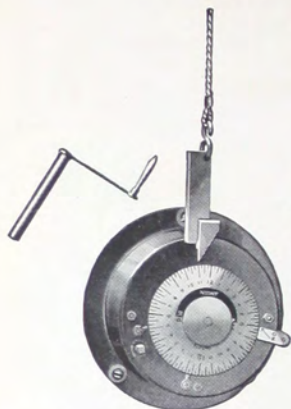

How To Operate

1. Set once a year.
2. Wind once a week.
3. Put on the hook every night.

Incidentally, putting on the hook will check the heater at any time and prevent incorrect and wasteful operation.

BOILER AND RADIATOR WRENCHES

SPUD WRENCH



List Price \$1.00

WATER REGULATOR

This regulator is all metal in construction and recommended for small water boilers. Its simplicity of construction renders it very sensitive and positive in action. It is made corrugated single disc plan and is composed of a special metal.



List Price \$10.00

Bronze and Liquids



Bronzing Liquid

List price per gal. . . . \$2.50
List price per half gal. \$1.50



Black Asphaltum

List price per gal. . . . \$3.00



Gold Bronze Powder

List price per lb. . . . \$2.00



Aluminum Bronze Powder

List price per lb. . . . \$2.00

"DISSOLENE"

Gallon Cans	\$6.75
1/2 Gallon Cans	3.50

Dissolene is a scientific preparation for the simple removal of the causes of unsteady water lines, priming, foaming and sluggish circulation of steam heating boilers. Full directions and quantities necessary to use, sent with each order.

CHIMNEY SWEEP

3 Pound Carton	\$1.00
5 Pound Carton	1.50

Chimney sweep provides a simple and efficient way of cleaning chimney flues and loosening the accumulated soot on boiler surfaces. Throw a handful or two over a cherry red fire, and close back damper, so as to let the fumes to the chimney slowly, trapping them as much as possible in the firepot. Let this burn for a quarter of an hour before recoaling. An ordinary flue brush will take off the oldest soot accumulation after this operation.

“Cash Acme” Hot Water House Heating System

Consists of combined Regulator, Relief Valve, By-Pass Valve and Strainer.

	List
Unit Complete (type A.G.).....	\$20.00
Damper Regulator—“Deegan”.....	13.00
Straight Thermometer.....	1.80

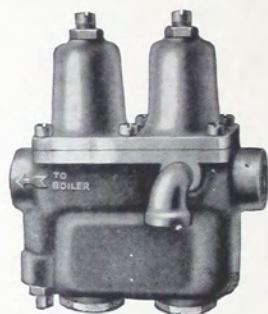

“Thrush” Hot Water House Heating System

TANK IN BASEMENT
“A” Equipment

Consists of Thrush Temperature Damper Regulator, Differential Pressure Relief, Air Tight Pressure Tank, Special Gauge and Thermometer.

	List
Size No. 0 up to 350. Radiation.....	\$33.00 net
Size No. 1 up to 750. Radiation.....	35.00 net
Size No. 2 up to 1250. Radiation.....	38.00 net
Size No. 3 up to 2000. Radiation.....	42.00 net

Thermostats and Limiting Devices only

(No Fittings)

Model	Description	Shipping Weight	List Price
J-O	Plain Thermostat.....	2 lbs.	\$31.00
J-1	One-day Clock Thermostat.....	4 lbs.	42.00
J-8	15-day Clock Thermostat (with jewelled balance).....	5 lbs.	60.00
B-2	Immersion Aquastat for Hot Water...	4 lbs.	30.00
C-1	Vaporstat—for Steam.....	4 lbs.	30.00
A-1	Vaportrol for Low Pressure Vapor.....	2 lbs.	18.00
B-1	Vaportrol for Mouat Vapor Systems...	2 lbs.	18.00
E-1	Surface Aquastat.....	2 lbs.	24.00
F-1	Airstat—for Warm Air.....	3 lbs.	22.00

MOTORS ONLY

(No Fittings)

Model	Description	Shipping Weight	List Price
J. G.	Gravity Motor.....	20 lbs.	\$25.00
J. S.	Spring Motor.....	16 lbs.	36.00
J. E.	Electric 110 V. 60 Cy. A. C.....	8 lbs.	60.00

IMPORTANT

For a J. E. Motor to operate on any current other than 110 volt 60 cycle A. C. add \$2.50 to the net price. This applies to 110 or 220 volt, 25, 30, 40 or 50 cycle A. C. and 110 or 220 volt D. C.

AUTOMATIC BOILER FEEDERS

No. 1 Non-overflow Type.....	\$24.00 net
No. 2 Duplex Type.....	32.00 net

MUELLER SYSTEM

System complete.....	\$32.50 net
System complete, without Regulator.....	24.50 net

JENNISON ADJUSTABLE FOOT RESTS

No. 1	No. 2	No. B3	No. 3	No. 4	No. 5	No. 6
$\frac{7}{8}$ "-1 $\frac{1}{4}$ "	1 $\frac{1}{4}$ "-1 $\frac{3}{4}$ "	1"-1 $\frac{3}{8}$ "	1 $\frac{1}{2}$ "-2 $\frac{1}{2}$ "	2"-3"	3"-4"	4"-5"
\$0.30	\$0.35	\$0.40	\$0.45	\$0.50	\$0.55	\$0.60 net



JENNISON—PATENTED DEC. 8, 1909

"Airstat" Humidifiers

Number.....	718	730	924	936
Size.....	7" x 18"	7" x 30"	9" x 24"	9" x 36"
List Price.....	\$3.00	\$4.00	\$5.00	\$6.00

Extra wicks 18" and 24", 50 cents each, 30" and 36", 80 cents each.

The "Airstat" humidifier is a simple means of supplying moisture to the air in an artificially heated room. A wick immersed in wells of water on both sides of the humidifier is stretched over a free-air space on top of the radiator, moistening the heated air as it rises from the radiator. It should be ordered long enough to cover the entire top of the radiator, or approximately so. It can be also used on hot air registers.

Folders with steamfitter's name and address thereon supplied upon application.



AIRSTAT

*for Health, Economy,
Efficiency and Comfort*

Cleanses the air you breathe

COAL-BURNING BLOWERS

Size	R.P.M.	Motor	Grate Area Sq. Ft. See Note No. 1	Dia. of Fan Outlet Inches	Height to Center Line of Outlet Inches	List Price
4-0	1750	$\frac{1}{30}$ H.P.-A.C.-D.C.	3	2 $\frac{3}{4}$	7 $\frac{15}{16}$	\$40
4-0	2500	$\frac{1}{30}$ H.P.-UNIV.	4 $\frac{1}{2}$	2 $\frac{3}{4}$	7 $\frac{15}{16}$	50
2-0	1750	$\frac{1}{30}$ H.P.-A.C.-D.C.	9	4 $\frac{1}{2}$	3 $\frac{7}{16}$	50
2-0	2500	$\frac{1}{6}$ H.P.-UNIV.	12	4 $\frac{1}{2}$	4 $\frac{1}{8}$	80
0	1750	$\frac{1}{8}$ H.P.-A.C.-D.C.	15	5 $\frac{1}{2}$	3 $\frac{11}{16}$	60
0	2400	$\frac{1}{2}$ H.P.-UNIV.	20	5 $\frac{1}{2}$	3 $\frac{11}{16}$	120
1	1750	$\frac{1}{4}$ H.P.-A.C.-D.C.	20	6 $\frac{1}{2}$	4 $\frac{1}{2}$	80
2	1750	$\frac{1}{2}$ H.P.-A.C.-D.C.	30	7 $\frac{1}{2}$	5	120
3	1750	1 $\frac{1}{2}$ H.P.-A.C.-D.C.	50	9	6 $\frac{1}{4}$	180

NOTE No. 1—Indicates size blower to be used on a given grate, under the following conditions:

- Heater carrying rated amount of radiation.
- Fuel used, No. 1 buckwheat or larger.
- Heater of round or sectional type.
- Standard grates.

