

# Honeywell Control Systems



*for*  
**RADIANT PANEL  
HEATING**

CATALOG and  
PRICE LIST

*1950*

**MINNEAPOLIS-HONEYWELL REGULATOR COMPANY**

A.I.A. FILE NO. 30-E JUN50

## TABLE OF CONTENTS

	PAGE
<b>TO THE HEATING DEALER</b> .....	2
ELECTRONIC MODUFLOW .....	2
OPERATION .....	2
OUTDOOR RESET CONTROL SYSTEM For Low Cost Housing .....	3
<b>FOR <b>ELECTRONIC</b> CONTROL</b>	
<b>RADIANT FLOOR PANEL SYSTEMS</b>	
Y216A and Y216B Moduflow Control Packages .....	4
<b>HOT WATER APPLICATION DATA</b>	
Forced Hot Water Floor Panel, Single Zone, with Domestic Hot Water .....	5
Forced Hot Water Floor Panel, Single Zone, without Domestic Hot Water .....	5
Forced Hot Water Floor Panel, Multiple Zone, with Domestic Hot Water .....	6
Forced Hot Water Floor Panel, Multiple Zone, without Domestic Hot Water .....	7
<b>WARM AIR APPLICATION DATA</b>	
Forced Warm Air Floor Panel, Single Zone .....	8
Forced Warm Air Floor Panel, Multiple Zone .....	8
<b>RADIANT CEILING PANEL SYSTEMS</b>	
Y210A and Y211A Moduflow Control Packages .....	9
<b>HOT WATER APPLICATION DATA</b>	
Forced Hot Water Ceiling Panel, Single Zone, with Domestic Hot Water .....	10
Forced Hot Water Ceiling Panel, Single Zone, without Domestic Hot Water .....	10
Forced Hot Water Ceiling Panel, Multiple Zone, with Domestic Hot Water .....	11

**CEILING  
PANEL**

MINNEAPOLIS-HONEYWELL AU

**FLOOR  
PANEL**

MINNEAPOLIS-HONEYWELL AU

**ZONE  
CONTROL**

**INDIVIDUAL  
ROOM CONTROL**

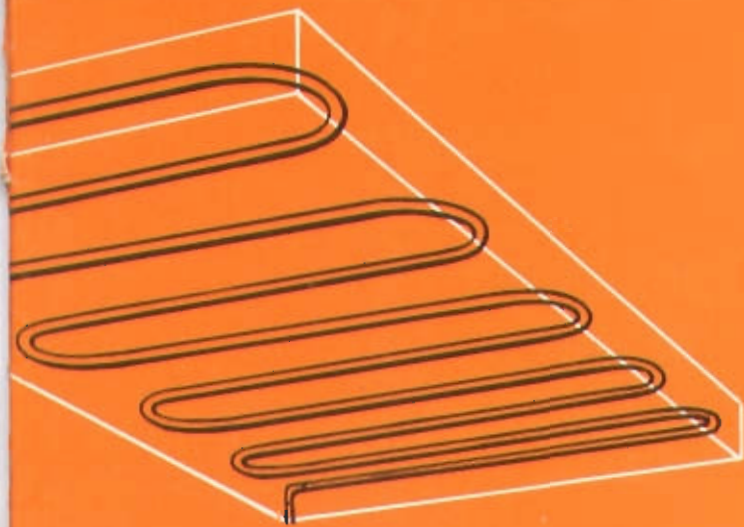

OMATIC CONTROL SYSTEMS

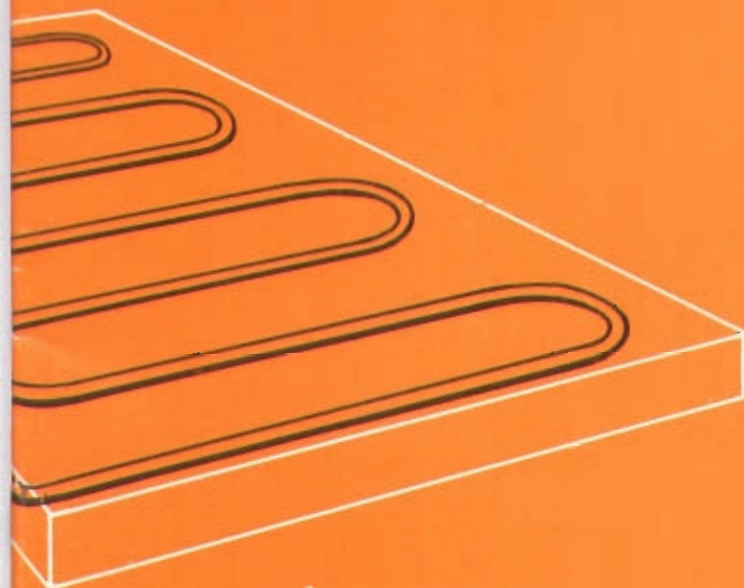

OMATIC CONTROL SYSTEMS

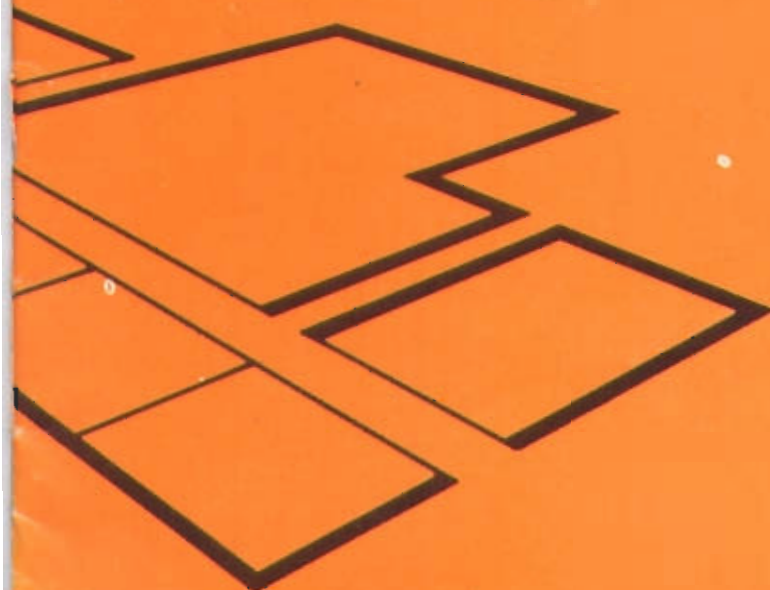

## TABLE OF CONTENTS

	PAGE
<b>HOT WATER APPLICATION (Continued)</b>	
Forced Hot Water Ceiling Panel, Multiple Zone, without Domestic Hot Water.....	12
<b>WARM AIR APPLICATION DATA</b>	
Forced Warm Air Ceiling Panel, Single Zone.....	13
Forced Warm Air Ceiling Panel, Multiple Zone.....	13
<b>FOR ELECTRIC CONTROL WITH OUTDOOR RESET</b>	
For panel heating in low-cost housing Y198B and Y199B Control Systems.....	14
Selection of Ratio for Outdoor Reset Control.....	14
TM81 Comfort Thermostat.....	15
TM850 Comfort Chronotherm.....	15
<b>HOT WATER APPLICATION DATA</b>	
Forced Hot Water Floor or Ceiling Panel, Single Zone.....	16
Forced Hot Water Floor or Ceiling Panel, Multiple Zone.....	17
<b>WARM AIR APPLICATION DATA</b>	
Forced Warm Air Floor or Ceiling Panel, Single Zone.....	18
Forced Warm Air Floor or Ceiling Panel, Multiple Zone.....	18
<b>ELECTRIC PANEL HEATING</b>	
Single and Multiple Zone.....	19
<b>CIRCULATORS</b> .....	20
<b>FLOW VALVES</b> .....	21
<b>Prices, Ordering, and Shipping Information</b> (see enclosed price sheet, SA1671A, inside back cover)	
<b>Minneapolis Honeywell Sales Offices</b> (back cover)	



## to the Heating Dealer



*Here is a book that you will want to refer to over and over again. It answers many radiant heating questions that customers frequently ask. It specifically deals with controls pertaining to the various types of panel heating.*

### CONVENIENT PACKAGE SETS

Each of the 6 Package Sets shown have characteristics which make them specially suited for a given type of radiant panel installation. Simply identify the type of radiant panel heating system you are planning, from the schematic diagrams shown. These diagrams indicate the recommended control devices in their relative positions. Both the controls and control accessories needed are listed with each system. A separate sheet inserted in the back of the book shows shipping weights and prices.

Because the panel heating system is an integral part of the structure, it is advantageous to consider every control problem while the job is in the early planning stage. You are always welcome to consult your nearest Honeywell branch office for whatever additional information you may require. These offices are listed on the back cover of this book.

### ELECTRONIC MODUFLOW

The Electronic Moduflow control system is the best—and the simplest—means of regulating radiant panel installations. The temperature sensing elements are simple electrical resistances—with no moving parts. They provide instant response to slight temperature changes, and their flexibility makes them ideally suited for radiant panel heating.

### OPERATION

In these Electronic Moduflow systems, one thermostat, the *Anticipator*, is located outdoors. It senses changes in outdoor temperature—enabling it to anticipate the heating demands before there has been a change in the rate of heat loss indoors. Another thermostat in the living area constantly checks indoor temperature.

In some installations, this indoor thermostat is supplemented by an *Averaging Ther-*

mostat located in another part of the dwelling.

Floor panel systems are provided with an *Immersion Thermostat* located in the return. It senses temperature of the heating medium as it leaves the panel. A special electronic circuit operates these thermostats in unison. They determine exactly how many minutes out of each hour (and at what intervals) the burner should operate.

### **ELECTRONIC MODUFLOW IS IDEAL CONTROL FOR RADIANT PANEL HEATING**

Electronic Moduflow's instant responsiveness and exceptional accuracy assure top performance of every type of radiant panel heating system. Lag in heating is minimized. Heat is supplied to the rooms according to exact comfort requirements.

Wherever you find a market for radiant panel heating in *homes*, in *commercial structures*, or in *industry* . . . you will find a logical application for a Honeywell Electronic Moduflow system. It provides the best control—yet, it's a simple system and is most economical to install.

### **OUTDOOR RESET CONTROL SYSTEM FOR LOW COST HOUSING**

Where radiant panel heating is specified for a smaller, low cost home, equipment selected—including automatic controls—must meet the low original cost requirement. However, satisfactory control of a panel system is difficult to obtain with only a basic room thermostat.

The Honeywell Outdoor Reset Control meets the requirements for low-cost housing—both from a standpoint of low original cost and improved control. This system operates the burner in accordance with outside temperature. A Honeywell Comfort Thermostat, with the new TM\* feature, maintains indoor temperatures at the desired level. Panel heating applications for the Outdoor Reset Control System are shown on pages 14 to 18.

\*TM—Thermostat Magic

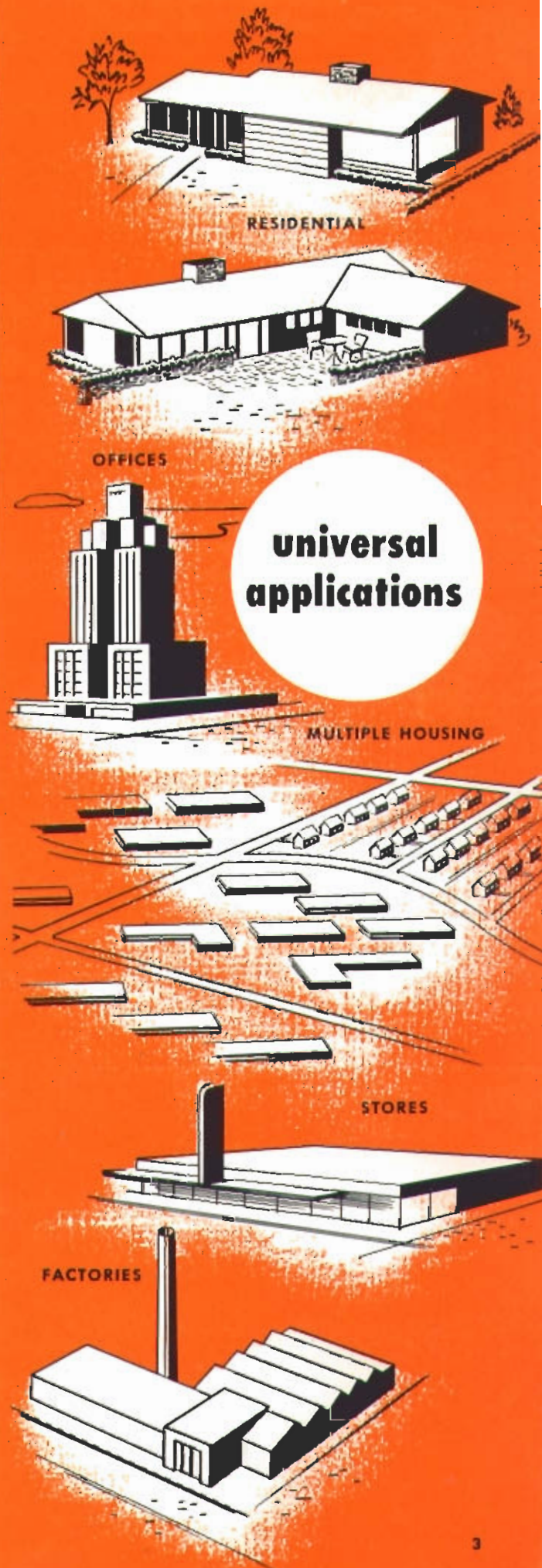

**ELECTRONIC  
MODUFLOW  
for  
RADIANT  
FLOOR PANEL  
SYSTEMS**

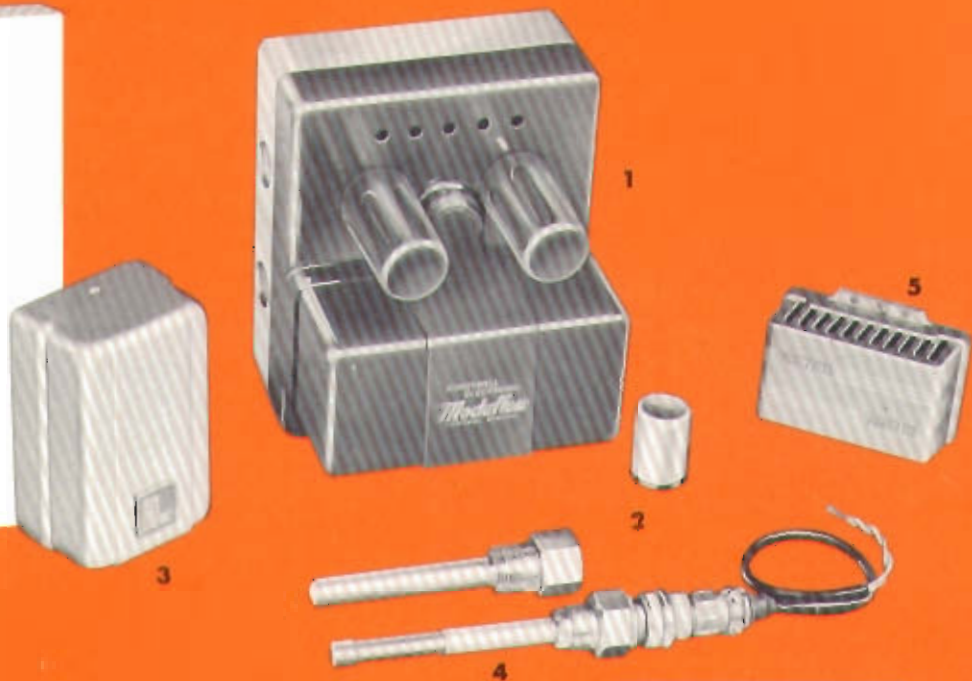

**ELECTRONIC MODUFLOW PACKAGE SET**



**T7000A5**  
Averaging Thermostat

**Y216A—Package Set consists of:**

1. R7012A Electronic Relay Amplifier (Max. Contact Capacity @ 115 V., A.C.: Running—4.6 Amp.; Locked Rotor—27.6 Amps.)
2. Q202A Cyclotron (3½ minute timing, Standard) Other timing available: 2½, 5-Min.
3. T7001A3 Outdoor Anticipator
4. L7001D4 Immersion Thermostat (with separable well)
5. T7000A6 Electronic Thermostat

**WHEN ORDERING SPECIFY:**

1. Package Set number
2. Voltage and Frequency
3. Cyclotron timing (3½-Min. Standard)
4. Size and type of Circulator, if used

The Y216A & B Package Sets, illustrated above, provide pin-point comfort control for all floor panel systems . . . whether they are gas, stoker, or oil-fired. They can be used with all burner relays and valves, along with standard high limit controls.

**Y216B—Package Set**

**With Averaging Thermostat (recommended for larger single or multiple zone installations)**

**consists of:**

1. R7012A Electronic Relay Amplifier (Max. Contact Capacity @ 115 V., A.C.: Running—4.6 Amp.; Locked Rotor—27.6 Amps.)
2. Q202A Cyclotron (3½ minute timing, Standard) Other timing available: 2½, 5-Min.
3. T7001A3 Outdoor Anticipator
4. L7001D4 Immersion Thermostat (With separable well)
5. T7000A8 Electronic Thermostat
6. T7000A5 Averaging Thermostat

**NOTE:**

Use only Honeywell Approved Plastic-Coated Wire for external circuits when installing Electronic Moduflow. See price sheet (inserted in back of book) for ordering information.

**FOR SHIPPING WEIGHTS AND PRICES SEE SEPARATE SHEET IN BACK OF BOOK**

# RADIANT FLOOR PANEL SYSTEMS *Single Zone*

## Forced Hot Water WITH Domestic Hot Water

**CONTROLS:** Y216A Electronic Moduflow Control Package, plus burner control (for gas, stoker, or oil), two L444A Aquastats (for high and low limit control).

**ACCESSORIES:** A Honeywell M417 Circulator, a V569 Flow Valve, two thermometer wells, and two hand adjusting valves.

Electronic Moduflow cycles the circulator. A low limit Aquastat controls burner operations. Normally the Electronic Relay can operate the circulator directly. If the motor load of the circulator exceeds 4.6 Amps. Running Current @ 115 V., an R19A Relay should be used.

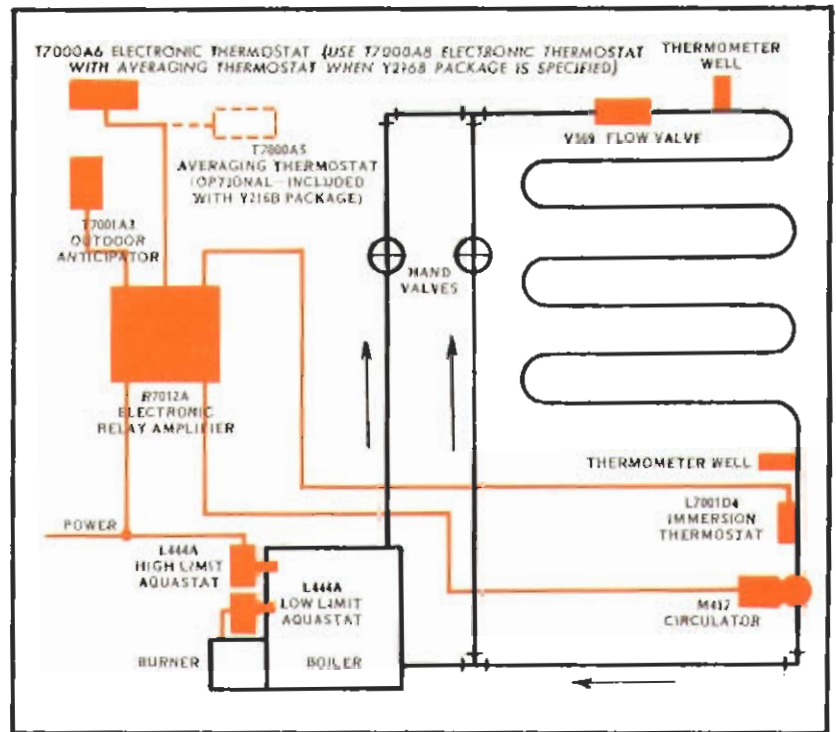

## Forced Hot Water WITHOUT Domestic Hot Water

**CONTROLS:** Y216A Electronic Moduflow Control Package, plus burner control (for gas, stoker, or oil), an L444A Aquastat (for high limit control), and an R132A Relay.

**ACCESSORIES:** An M417 Honeywell Circulator, two thermometer wells, and a V569 Flow Valve.

Electronic Moduflow controls the burner and circulator simultaneously through an R132A Relay. A high limit Aquastat protects boiler operation.

**ELECTRONIC MODUFLOW CONTROL SYSTEMS USED WITH THESE APPLICATIONS ARE SHOWN ON PAGE 4.**

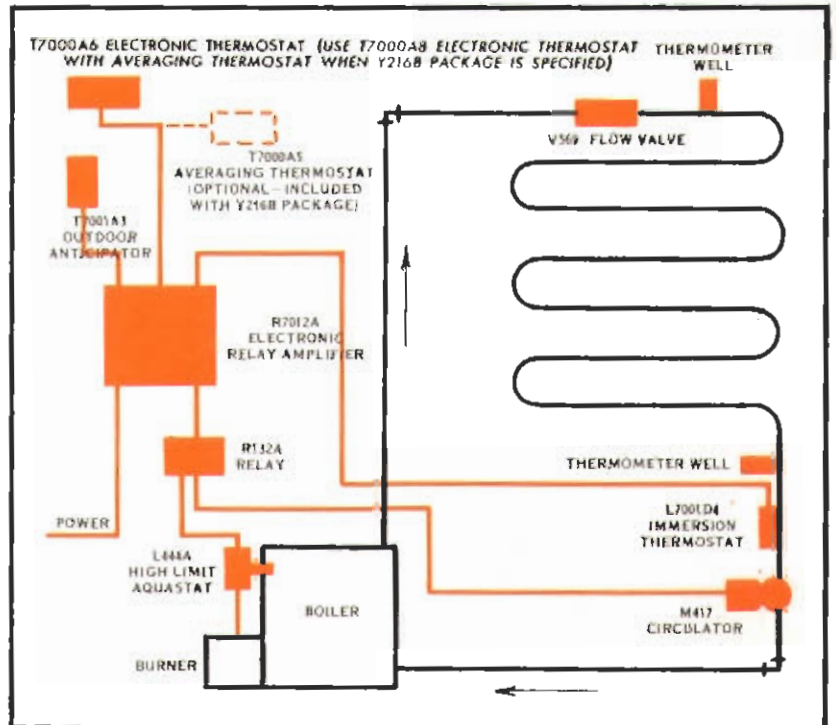

# ELECTRONIC MODUFLOW for Radiant Floor Panel Systems

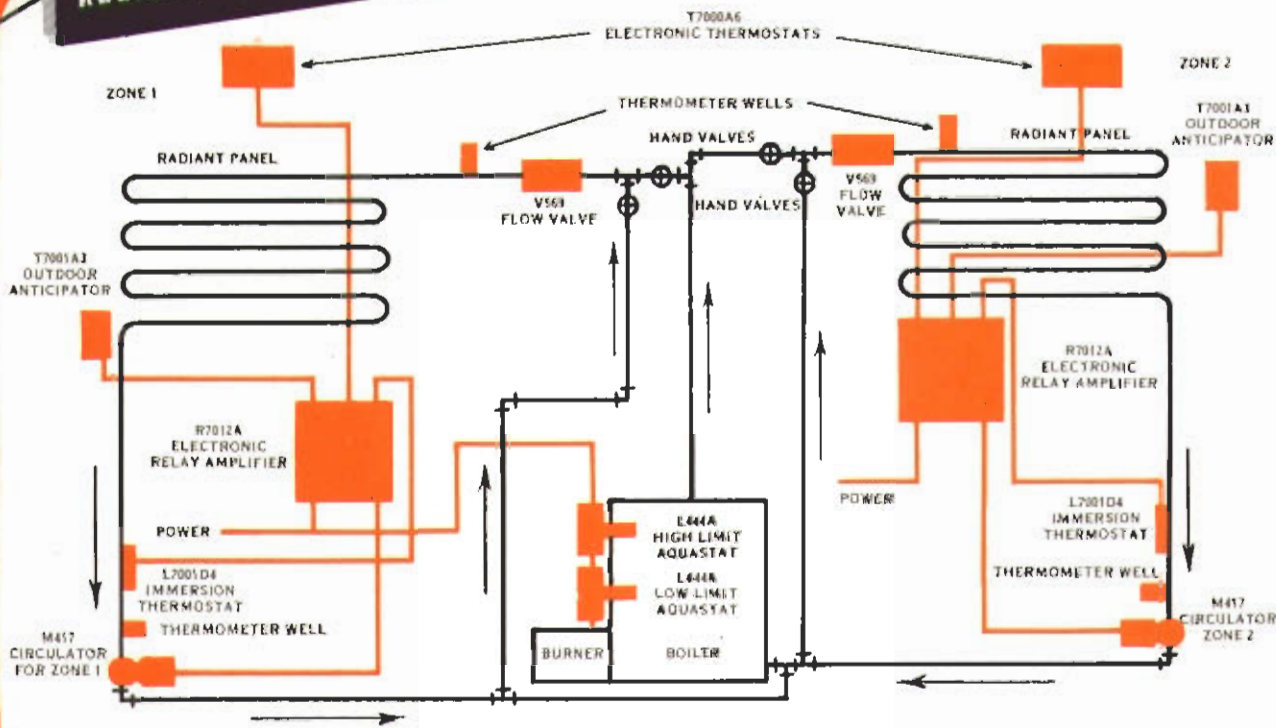

## FORCED HOT WATER FLOOR PANEL *Multiple Zone* WITH *Domestic Hot Water*

**Zone Control** is the logical approach to the comfort heating problem in large or rambling structures. It is simply the grouping of rooms or areas having common characteristics in heat load, exposure, or occupancy. Each zone has its own complete Electronic Moduflow control system which accurately compensates for every temperature variation in that area.

### CONTROLS:

One Y216A Electronic Moduflow Package for each zone, control valve or relay (for gas, stoker, or oil), two L444A Aquastats (for high and low limit control).

### ACCESSORIES:

For each zone—one Honeywell M417 Circulator, a V569 Flow Valve, a thermometer well, and two hand adjusting valves.

An Electronic Moduflow Control System is required for each zone. It cycles the zone circulator. In a majority of installations, the Electronic Relay is of adequate capacity to operate the circulator directly. If the motor load of the circulator exceeds 4.6 Amps. Running Current @ 115V., a Honeywell R19A Relay should be used. Hand valves on the supply and bypass return from each zone are adjusted to restrict panels from exceeding design temperature. A low limit Aquastat, set to maintain hot water for domestic use, operates the burner.



# FORCED HOT WATER FLOOR PANEL *Multiple Zone* **WITHOUT** *Domestic Hot Water*

## CONTROLS:

One Y216A Electronic Moduflow Package for each zone.  
 A control valve or relay (for gas, stoker, or oil), two  
 L444A Aquastats (for high and low limit control).

## ACCESSORIES:

For each zone—a Honeywell M417 Circulator, a V569  
 Flow Valve, and a thermometer well.

Each zone is controlled by an Electronic Moduflow System which cycles the zone circulator. Normally the Electronic Relay can operate the circulator directly. If the motor load of the circulator exceeds 4.6 Amps. Running Current @ 115V., a Honeywell R19A Relay should be used. A low limit Aquastat operates the burner.

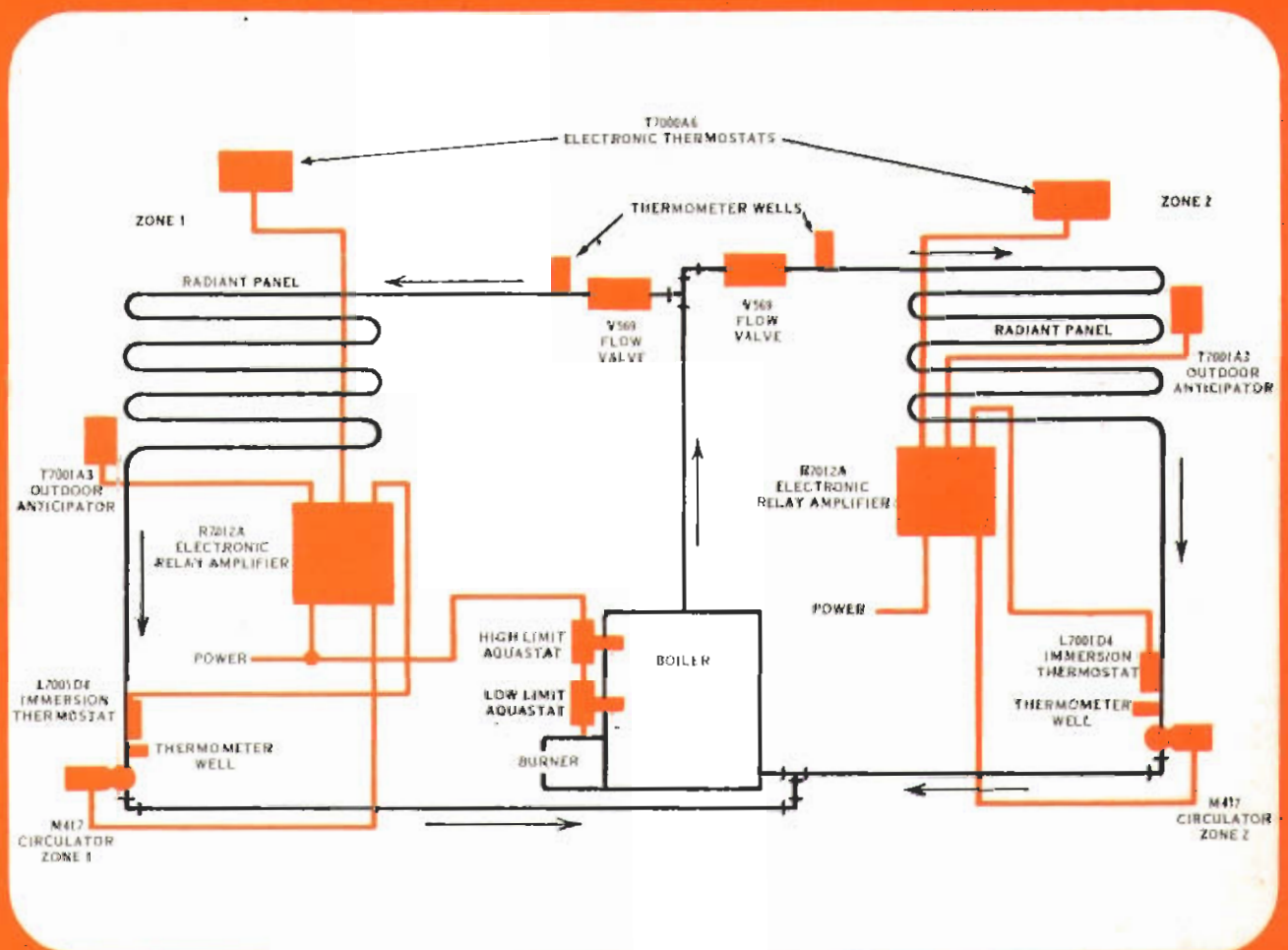

ELECTRONIC MODUFLOW SYSTEMS USED WITH  
 THESE APPLICATIONS ARE SHOWN ON PAGE 4

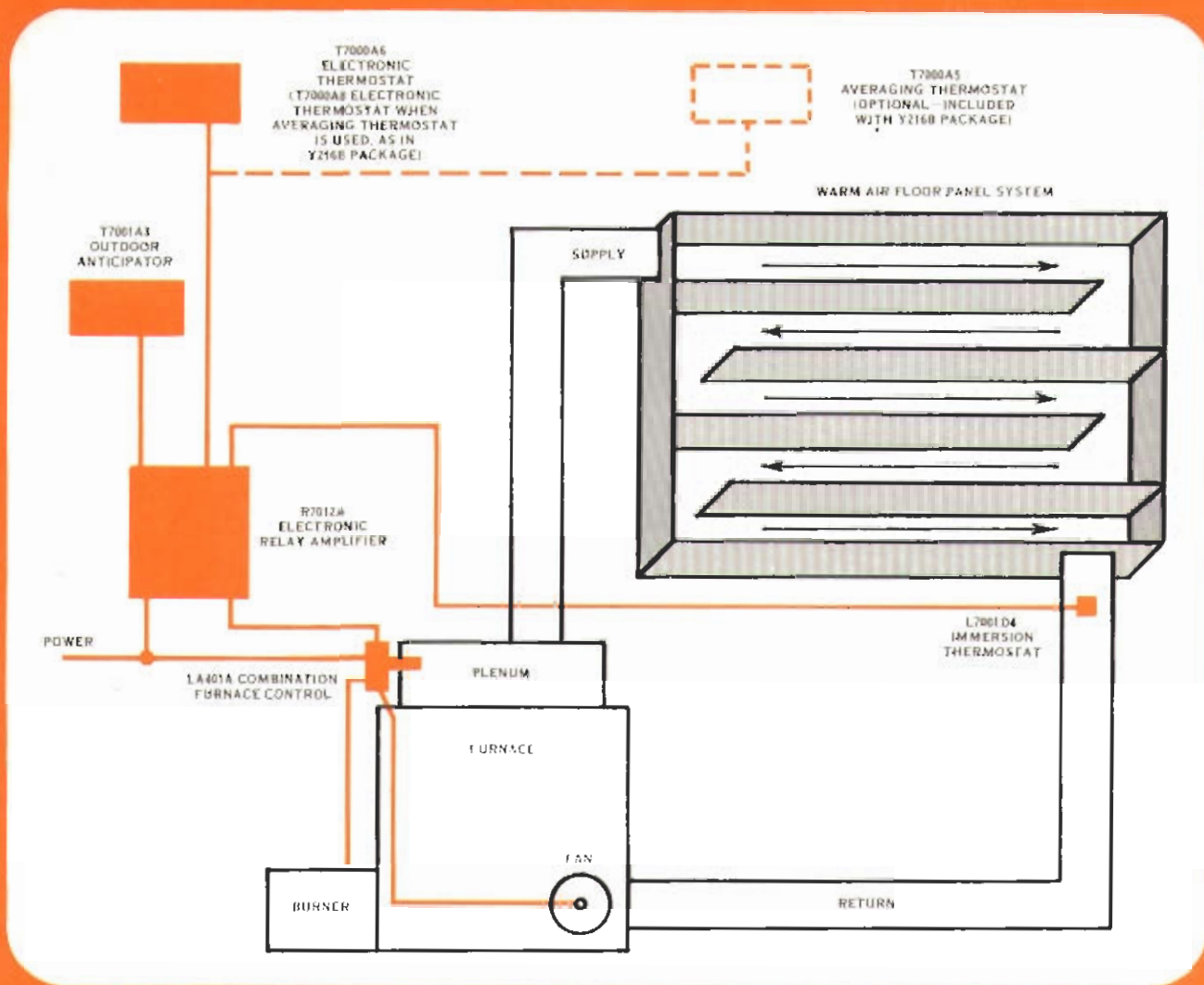

## FORCED WARM AIR RADIANT FLOOR PANEL SYSTEMS

### Single Zone

#### CONTROLS:

Y216A Electronic Moduflow Package, LA401 Combination Control, plus control valve or relay (for gas, stoker, or oil).

#### SINGLE ZONE:

The Electronic Moduflow System operates the burner. The Combination Furnace Control is set

for practically continuous fan operation, and also serves as high limit.

#### MULTIPLE ZONE:

Consult your nearest Honeywell office (see listing on back cover). They will welcome your inquiry pertaining to control recommendations for this type of panel heating installation.

**ELECTRONIC MODUFLOW CONTROL SYSTEMS USED WITH THESE APPLICATIONS ARE SHOWN ON PAGE 4.**

# ELECTRONIC MODUFLOW for RADIANT CEILING PANEL SYSTEMS

Automatic Day-Night Control  
for Ceiling Panel Systems

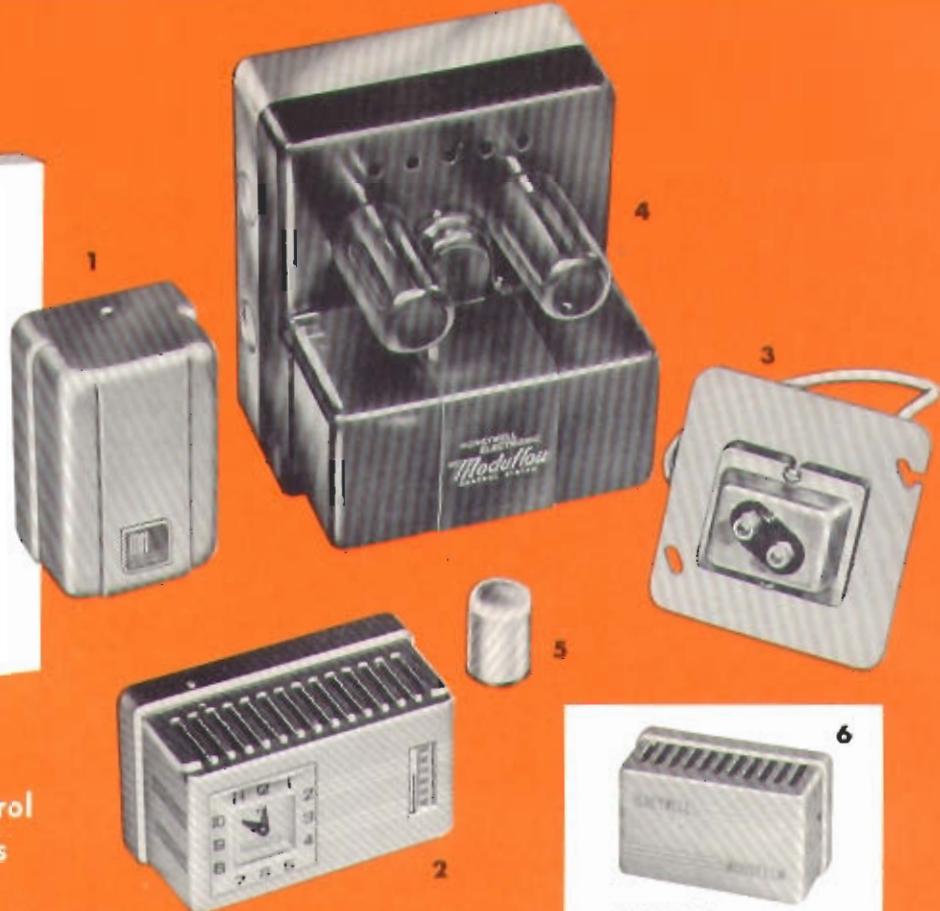

T7000A5  
Averaging Thermostat

## Y210A Package Set consists of:

1. T7001A4 Outdoor Anticipator
2. TA7002A2 Electronic Chronotherm
3. AT75A1 Transformer (for Chronotherm clock) 115 volt, 60 cycles, Standard
4. R7012A Electronic Relay Amplifier (Max. contact capacity @ 115V., A.C.: Running—4.6 Amp.; Locked Rotor—27.6 Amp.)
5. Q202A Cyler (3½ minute timing Standard) Other timing available: 2½, 5-Min.

### WHEN ORDERING SPECIFY:

1. Package Set number
2. Voltage and Frequency
3. Cyler timing (3½ minute Standard)
4. Size and type of Circulator, if used.

The Electronic Moduflow Systems for ceiling panel applications may be used on gas, oil, or stoker-fired heating systems and with all types of burner controls.

### ELECTRONIC CHRONOTHERM

The Electronic Chronotherm is an added feature which is included with the Y210A and Y211A Control Packages for radiant ceiling panel systems.

This device consists of an electronic sensing element, manual adjustments for setting the room temperature, and an electric clock which provides completely automatic day-night control. Multiple zone applications use an Electronic Chronotherm to regulate the day-night heating needs independently in each zone.

## Y211A Package Set

With Averaging Thermostat (recommended for larger single or multiple zone installations)

### consists of:

1. T7001A4 Outdoor Anticipator
2. TA7002A1 Electronic Chronotherm
3. AT75A1 Transformer (for Chronotherm clock) 115 volt, 60 cycles, Standard
4. R7012A Electronic Relay Amplifier (Max. contact capacity @ 115 V., A.C.: Running—4.6 Amp.; Locked Rotor—27.6 Amp.)
5. Q202A Cyler (3½ minute timing Standard) Other timing available: 2½, 5-Min.
6. T7000A5 Averaging Thermostat

The Y211A Package Set is particularly well suited for the more extensive rambler, and the larger home or commercial structure where indoor control from more than one point is desirable.

### NOTE:

Use only Honeywell Approved Plastic-Coated Wire for external circuits when installing Electronic Moduflow. See price sheet (inserted in back of book) for ordering information.

FOR SHIPPING WEIGHTS AND PRICES  
SEE SEPARATE SHEET IN BACK OF BOOK

# RADIANT CEILING PANEL SYSTEMS *Single Zone*

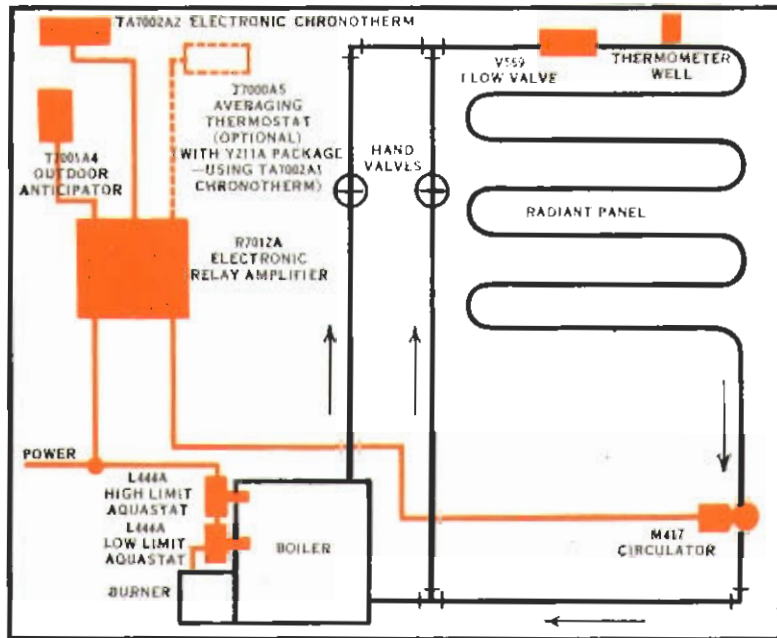

The Electronic Moduflow System cycles the circulator. A bypass from the return to the supply is regulated by hand valves so that water entering the panel system does not exceed panel design temperature. The Electronic Relay is generally of sufficient capacity to operate the circulator directly. If the motor load of the circulator exceeds 4.6 Amps. Running Current @ 115V., a Honeywell R19A Relay should be used. A low limit Aquastat, set to provide domestic hot water, operates the burner.

## Forced Hot Water

**WITH**

## Domestic Hot Water

### CONTROLS:

Y210A Electronic Moduflow Control Package, plus control valve or relay (for gas, stoker, or oil), two L444A Aquastats (for high and low limit control).

### ACCESSORIES:

A Honeywell M417 Circulator, V569 Flow Valve, a thermometer well, and two hand adjusting valves.

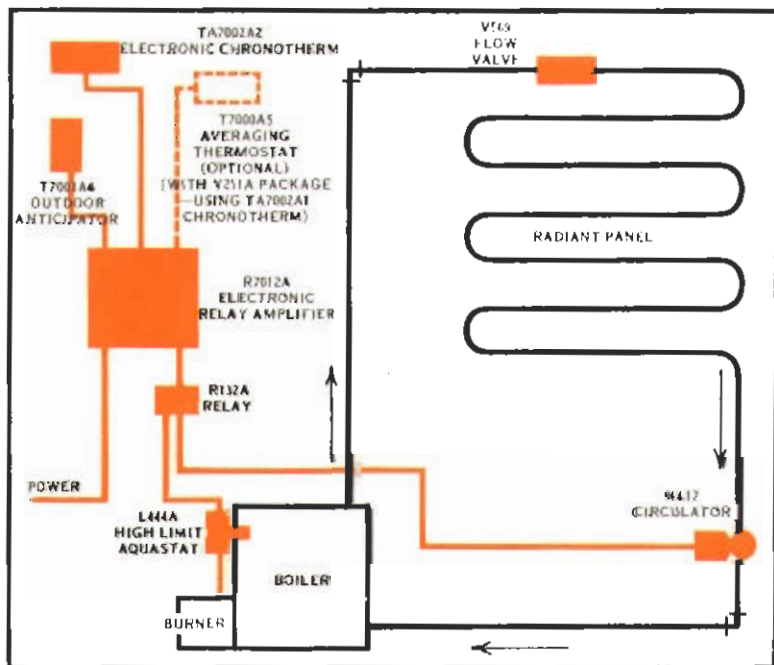

## Forced Hot Water

**WITHOUT**

## Domestic Hot Water

### CONTROLS:

Y210A Electronic Moduflow Control Package, plus control valve or relay (for gas, stoker, or oil), and an L444A high limit Aquastat, and one R132A Relay.

### ACCESSORIES:

A Honeywell M417 Circulator and a V569 Flow Valve.

Electronic Moduflow Controls the burner and circulator simultaneously through an R132A Relay. A high limit Aquastat protects boiler operation.

# ELECTRONIC MODUFLOW for Radiant Ceiling Panel Systems

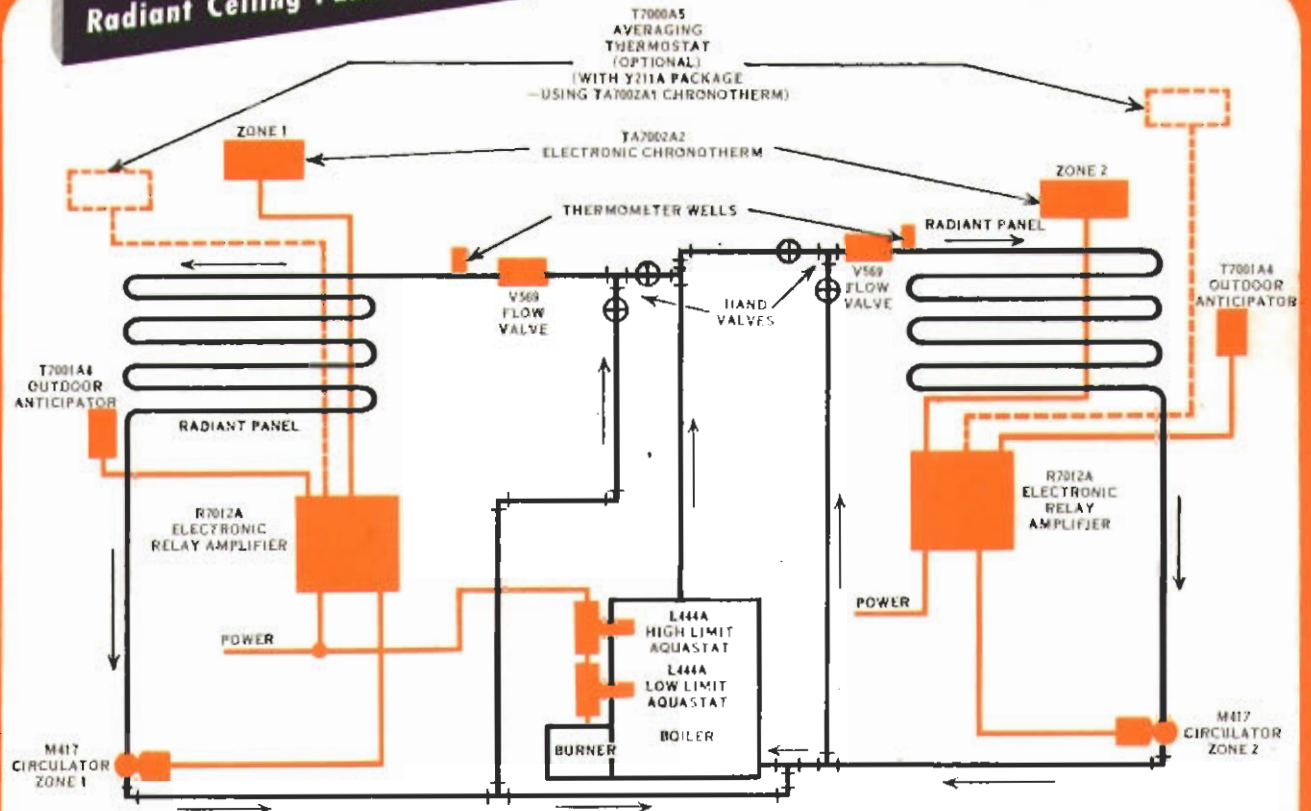

## FORCED HOT WATER CEILING PANEL *Multiple Zone* WITH *Domestic Hot Water*

### CONTROLS:

One Y210A Electronic Moduflow Control Package for each zone, control valve or relay (for gas, stoker, or oil), and two L444A Aquastats (for high and low limit control).

### ACCESSORIES:

For each zone—a Honeywell M417 Circulator, a V569 Flow Valve, a thermometer well and two hand adjusting valves.

An Electronic Moduflow System is required for each zone to cycle the zone circulator. Normally the Electronic Relay is of adequate capacity to operate the circulator directly. Where the motor load of the circulator exceeds 4.6 Amps. Running Current @ 115V., a Honeywell R19A Relay should be used. A manual bypass with hand valves is required for each zone to prevent panels from exceeding design temperature. A low limit Aquastat, set for domestic hot water use, operates the burner.

ELECTRONIC MODUFLOW CONTROL SYSTEMS USED WITH THESE APPLICATIONS ARE SHOWN ON PAGE 9.

# ELECTRONIC MODUFLOW for Radiant Ceiling Panel Systems

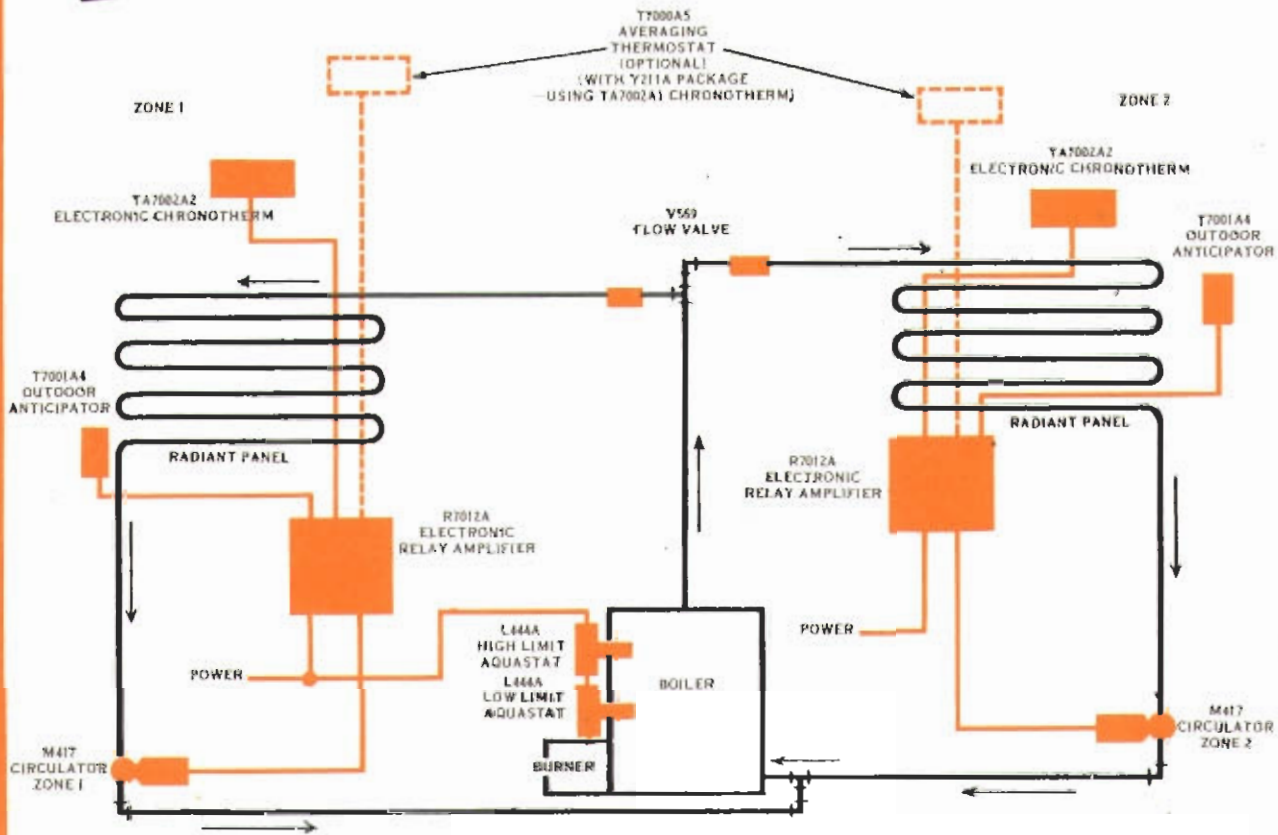

## FORCED HOT WATER CEILING PANEL *Multiple Zone* **WITHOUT** *Domestic Hot Water*

Each zone is controlled by its own Electronic Moduflow System, which cycles the zone circulator.

The Electronic Relay is generally of sufficient capacity to operate the circulator directly.

If the motor load of the circulator exceeds 4.6 Amps. Running Current @ 115V.,

a Honeywell R19A Relay should be used. A low limit Aquastat operates the burner.

### CONTROLS:

One Y210A Electronic Moduflow Control Package for each zone, a control valve or relay (for gas, stoker, or oil), two L444A Aquastats (for high and low limit control).

### ACCESSORIES:

Each zone requires a Honeywell M417 Circulator and a Y569 Flow Valve.

**ELECTRONIC MODUFLOW CONTROL SYSTEMS USED WITH THESE APPLICATIONS ARE SHOWN ON PAGE 9.**

# RADIANT CEILING PANEL SYSTEMS *Forced Warm Air*

## Single Zone

### CONTROLS:

Y210A Electronic Moduflow Control Package, plus control valve or relay (for gas, stoker, or oil), and an LA401A Combination Control.

### SINGLE ZONE:

Electronic Moduflow controls the burner. A combination Furnace Control, set for practically contin-

uous operation of the fan, also serves as the high limit control.

### MULTIPLE ZONE:

This type of warm air panel heating requires individual analysis for best results. Consult your nearest Honeywell branch office (see listing on back cover). They will be glad to make a complete study of your control needs.

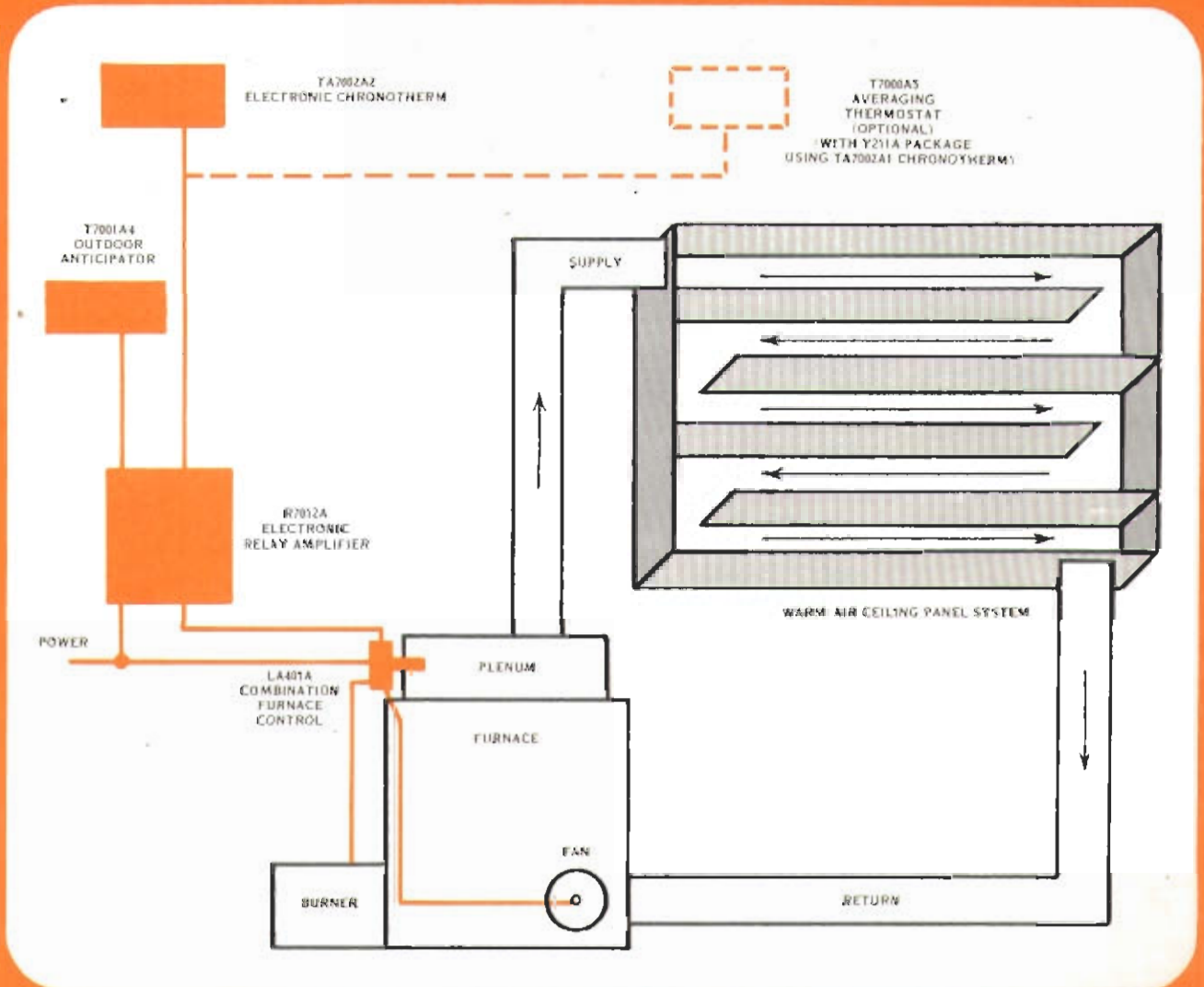

**HONEYWELL**  
**ELECTRIC**  
**CONTROL**  
with  
**Outdoor Reset**

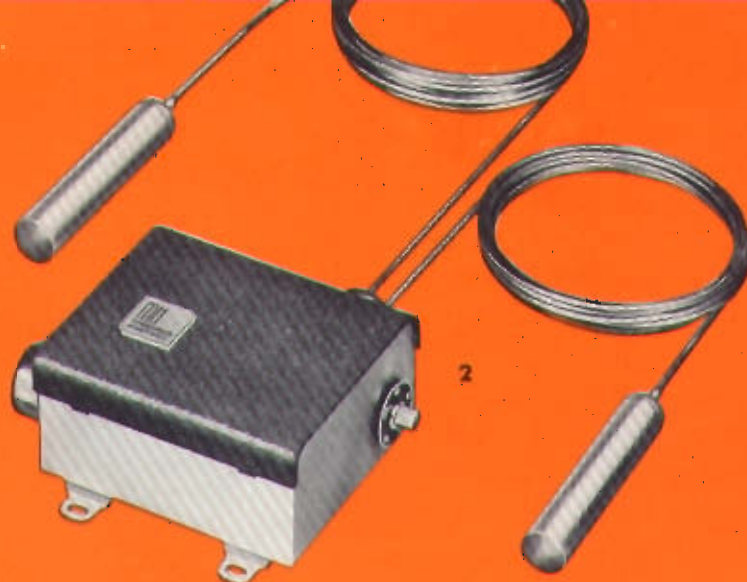

**Moderately Priced, Dependable Control for LOW-COST Housing!**  
for FLOOR and CEILING RADIANT PANELS

**Y198B Control Package**  
for Forced Warm Air consists of:

1. TM81 Comfort Thermostat
2. T418B Outdoor Reset Control

**WHEN ORDERING SPECIFY:**

1. Package Set number
2. Voltage and Frequency
3. T418B ratio  
(see Ratio Selection Chart, below)
4. Size and type of Circulator, if used.

**Y199B Control Package**  
for Forced Hot Water consists of:

1. TM81 Comfort Thermostat
2. T418B Outdoor Reset Control
3. R19A Relay

**HOW TO SELECT PROPER RATIO FOR OUTDOOR RESET CONTROL**

The T418B Outdoor Reset Control adjusts the temperature of the heating medium (warm air or hot water) according to outdoor temperature. It operates on a set ratio. A device having a 1-to-1 ratio indicates that for each 1° temperature drop outside, temperature of the heating medium is raised 1°. A ratio of 1-to-1½ raises the setting of the indoor bulb 1½° for each degree of outdoor temperature drop.

**Example:**

Outdoor Design Temperature (for your locality) 0  
Calculated Temperature of heating medium under design heating load 140°

On the chart at left, locate 140° (under "Maximum Temperature of Heating Medium") and read down the 140° column to a point opposite 0° (shown in left-hand column—under "Outdoor Design Temp.") The reading at this point indicates a 1-to-1 ratio.

OUTDOOR DESIGN TEMPERATURE	MAXIMUM TEMPERATURE OF HEATING MEDIUM				
	Degrees F.	100°	120°	140°	160°
50		1:1½			
30		1½:1	1:1	1:1½	
10			1½:1	1:1	1:1½
0			1½:1	1:1	1:1
-10				1½:1	1:1
-20				1½:1	1:1
-30				1½:1	1:1

SHIPPING WEIGHTS AND PRICES ARE ON SEPARATE SHEET IN BACK OF BOOK



## RESET CONTROL KEEPS HEATING IN STEP WITH OUTDOOR TEMPERATURE

The Outdoor Reset Control is a simple, dependable mercury switch type control, which operates the burner according to outdoor temperature. One remote bulb is mounted outdoors, the other bulb is inserted in the hot water boiler or warm air duct. Control point of the heating medium is varied in relation to outside temperature.

## COMFORT THERMOSTAT OFFERS IMPROVED TM\* CONTROL

TM\* -- *Thermostat Magic* -- now standard on all Honeywell domestic thermostats - provides controlled frequency of burner operation. Heat is provided in accordance with outside temperature--smaller portions in mild weather, progressively more often, and in progressively larger portions, as the outside temperature drops.

For Ceiling Panel Systems...

## TM\* COMFORT CHRONOTHERM AUTOMATIC DAY-NIGHT CONTROL

For improved operation on all ceiling panel systems, specify the new CHRONOTHERM, with *Thermostat Magic*. Customers appreciate the *comfort, convenience, and economy* of day-night control. At night, the electric clock thermostat automatically lowers the temperature setting. At a pre-determined time each morning, heat is restored to the normal day-time level. The TM comfort feature provides a stable flow of warmth throughout the system... always in keeping with heat requirements.

TM Thermostat Magic



T418B Outdoor  
Reset Control



TM81 Comfort  
Thermostat



TM850A  
Comfort Chronotherm

## OUTDOOR RESET CONTROL SYSTEM

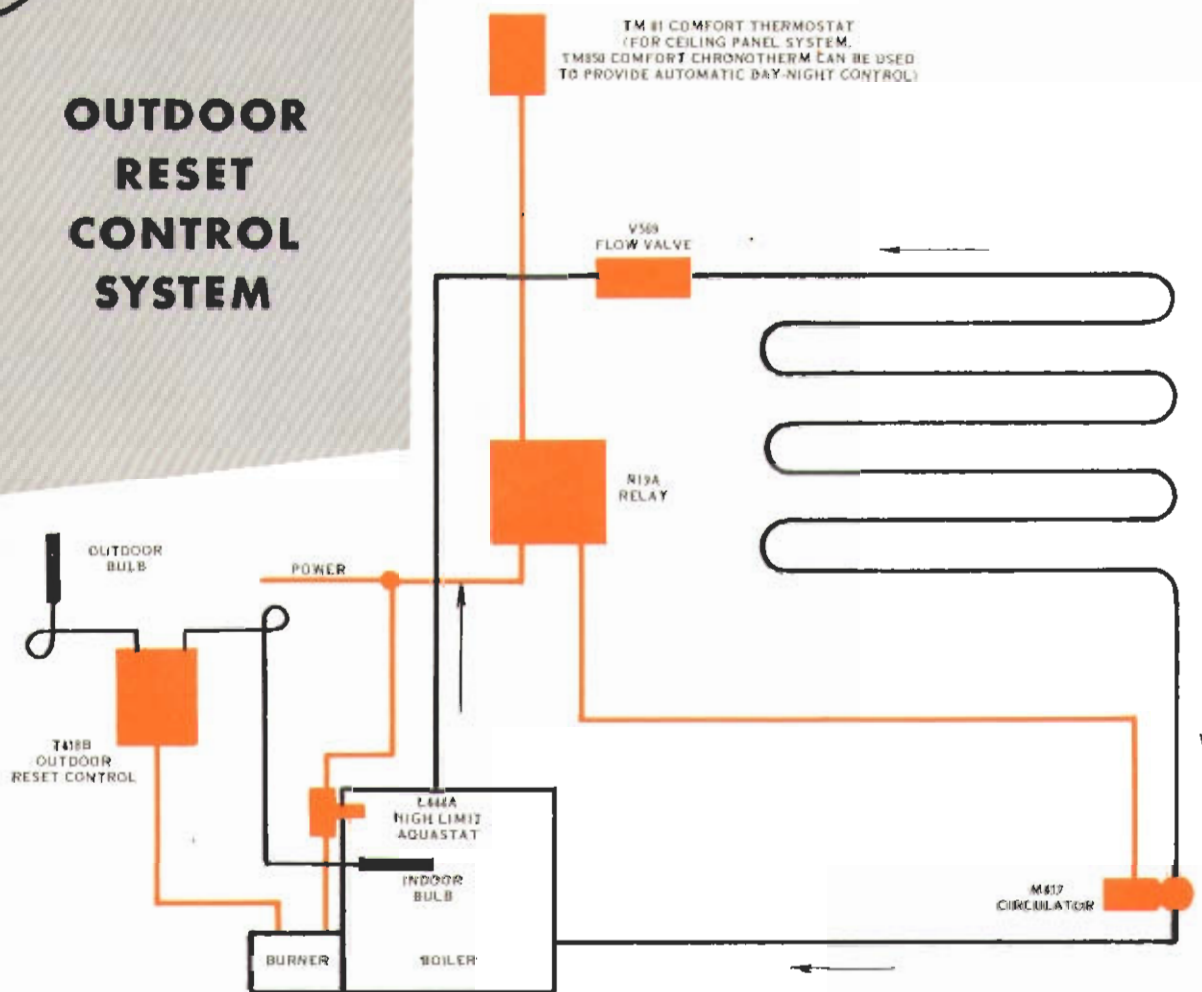

## FORCED HOT WATER FLOOR OR CEILING PANEL Single Zone **WITHOUT** Domestic Hot Water

### CONTROLS:

Y199B Control Package valve or relay control (for gas, stoker, or oil), L444A Aquastat for high limit, and an R19A Relay.

### ACCESSORIES:

Honeywell M417 Circulator, and V569 Flow Valve.

The Outdoor Reset Control operates the burner according to outside temperature. The Comfort Thermostat, mounted in the living area, cycles the circulator in relation to indoor temperature requirements. The R19A Relay handles the line voltage requirements of the circulator.

**OUTDOOR RESET CONTROL SYSTEM USED WITH THIS APPLICATION IS SHOWN ON PAGE 14**

# FORCED HOT WATER FLOOR OR CEILING PANEL

## Multiple Zone **WITHOUT** Domestic Hot Water

**CONTROLS:** One T418B Outdoor Reset Control, one burner valve or relay control (for gas, stoker, or oil), one L444A Aquastat for high limit control. For each zone—add one TM81 Comfort Thermostat, one R19A Relay.

**ACCESSORIES:** For each zone—add one Honeywell M417 Circulator, one V569 Flow Valve.

The Outdoor Reset Control operates the burner in keeping with the outside temperature. A Comfort Thermostat in each zone operates the zone circulator through an R19A Relay.

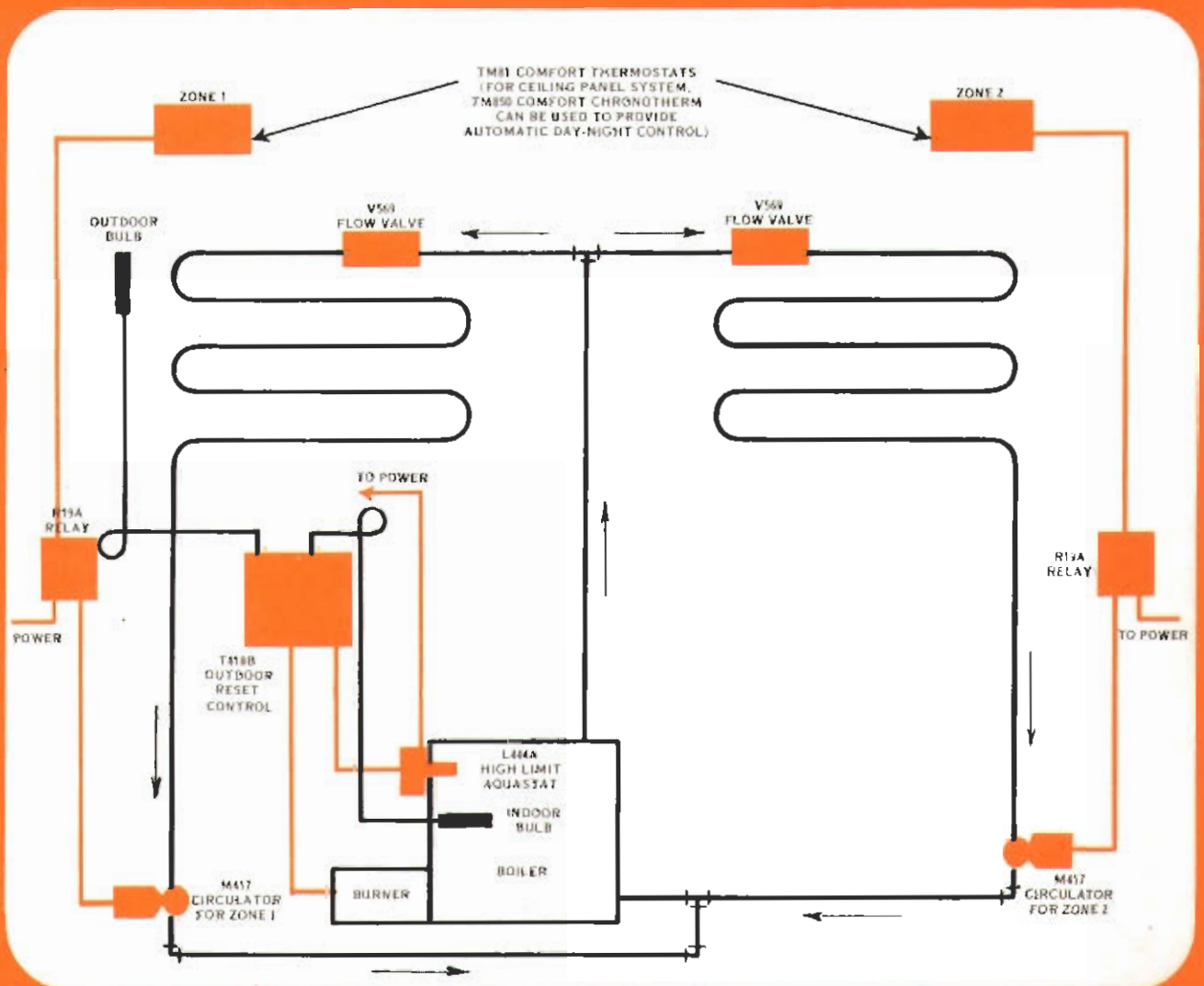

OUTDOOR RESET CONTROL SYSTEM USED WITH THESE APPLICATIONS IS SHOWN ON PAGE 14

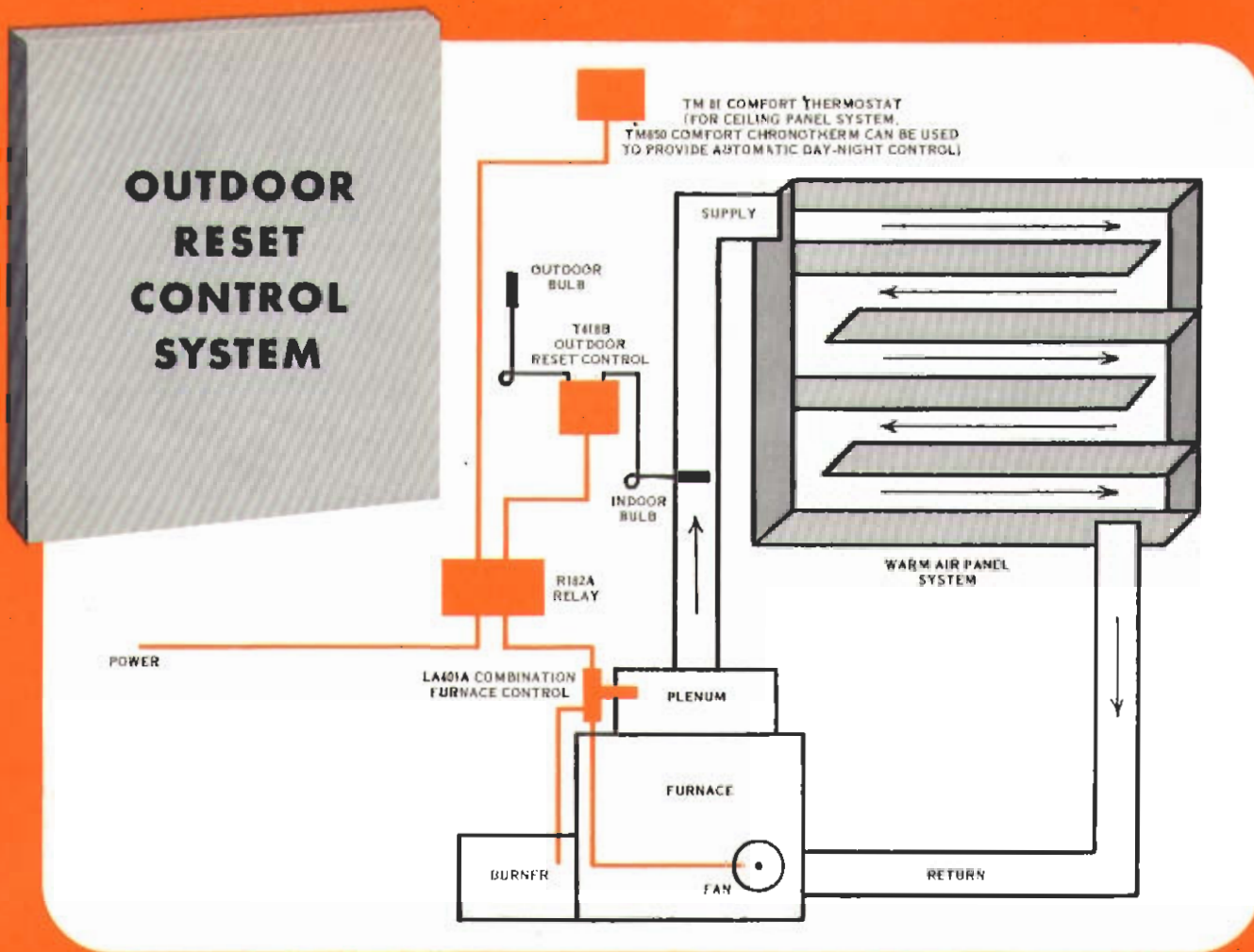

## FORCED WARM AIR *Floor or Ceiling Panel* *Single Zone*

### CONTROLS:

Y198B Control Package, valve or relay control (for gas, stoker, oil), an LA401 Combination Furnace Control, and an R182A Relay.

### SINGLE ZONE:

The Comfort Thermostat starts and stops the burner according to indoor heating demands. The Outdoor Reset Control limits air temperature to the panel in relation to outdoor temperature. A combination Furnace Control, set for practically continuous fan operation,

also serves as the high limit control.

### MULTIPLE ZONE:

For this type of installation, it is advisable to consult your nearest Honeywell branch office (see listing on back cover). This will enable qualified Honeywell engineers to fully consider control needs.

**OUTDOOR RESET CONTROL SYSTEM USED WITH THIS APPLICATION IS SHOWN ON PAGE 14**

# ELECTRIC PANEL HEATING

## WALL and CEILING PANEL SYSTEMS

### Single and Multiple Zones

#### CONTROLS:

TM81 Comfort Thermostat, or TM850 Comfort Chronotherm (for automatic day-night control); plus from one to three R882C Relays, depending on number of panels under control of the thermostat.

#### ZONING OR INDIVIDUAL ROOM CONTROL

Each thermostat can control up to five panels\* of 1000 Watt heater load per unit (illustrated below). This is accomplished through using up to three inter-connected relays.

\*Refer to schematic diagram for contact load limits.



TM81 Comfort Thermostat



R882C Relay

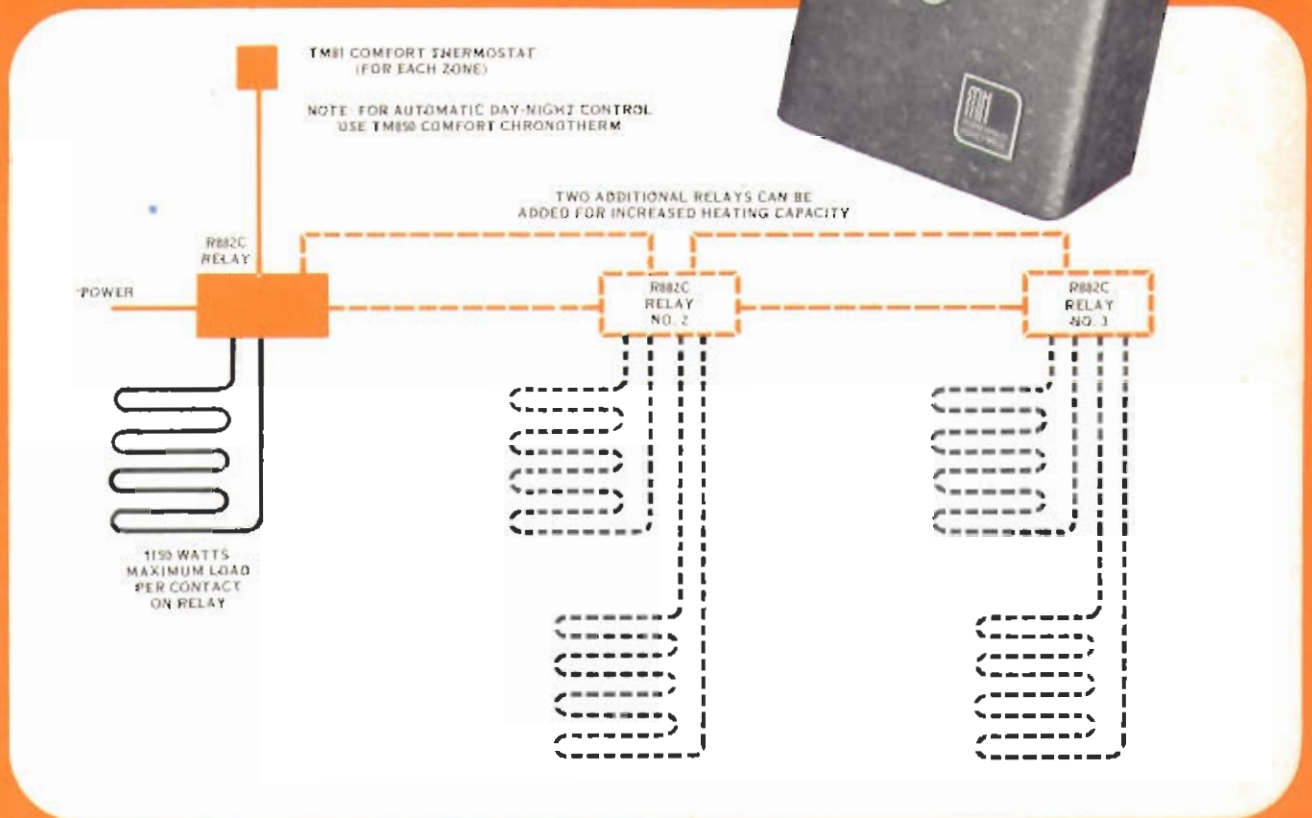

FOR SHIPPING WEIGHTS AND PRICES SEE SEPARATE SHEET IN BACK OF BOOK

# CIRCULATORS

**M417A WATER CIRCULATOR**

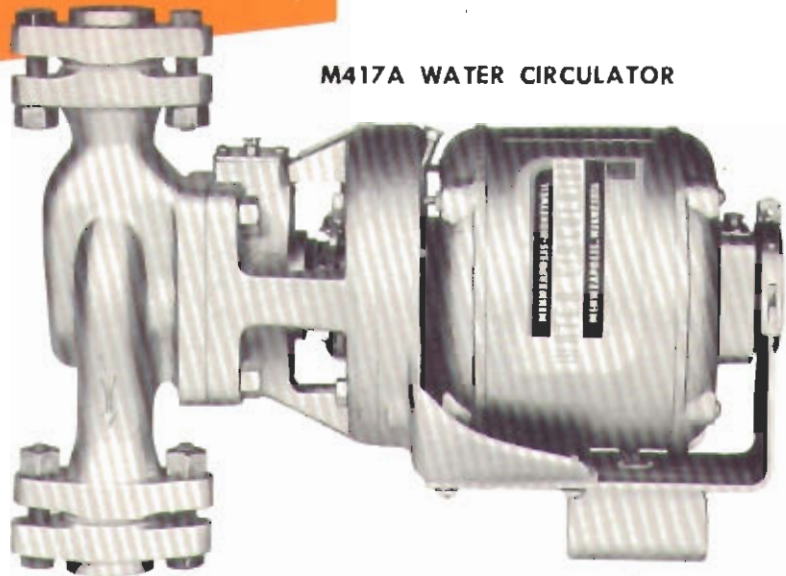
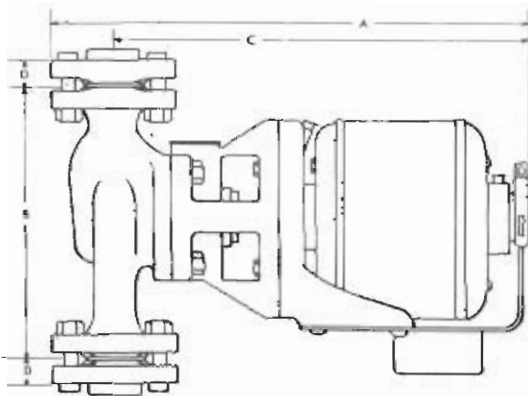

An M417A Water Circulator is ideal for the forced hot water radiant panel control systems described in this catalog.

All A.C. single phase model circulators are equipped with a recycling overload cutout, which protects the motor from damage should a dead stall be caused by foreign matter in the pump. The thermal overload cutout also protects the motor from overheating due to lack of lubrication.

All circulator connections are flanged, and companion flanges, bolts, and gaskets are included for installation of the circulators. Voltage and frequency are 115, 60 cycle standard.

**SPECIAL FEATURES AVAILABLE:**

1. For other than standard voltages and frequencies, write for quotation.

**WHEN ORDERING SPECIFY:**

1. Type number
2. Size
3. Voltage and frequency

NOTE: For installations having greater than average resistance in the panel system, the M417 High Velocity Circulators should be specified.

Type No.	Size"	Motor (S.P.)	DIMENSIONS				Head Ft. of Water	CAPACITY—GALLONS PER MINUTE †										
			A	B	C	D		1	2	3	4	5	6	7	8	9		
M417A	3/4"	1/15 H.P.	14-9/16"	6-5/16"	12-9/16"	11/16"		18	17	13	10							
M417A	1"	1/12 H.P.	14-9/16"	6-5/16"	12-9/16"	11/16"		23	20	16	12	7						
M417A	1 1/4"	1/6 H.P.	15-3/8"	8-1/2"	13-1/4"	3/4"		33	30	25	20	15	5					
M417A	1 1/2"	1/6 H.P.	15-9/16"	8-1/2"	13-1/4"	3/4"		44	41	37	33	26	16					
M417A	2"	1/6 H.P.	15-7/8"	8-1/2"	13-1/4"	15/16"		68	65	62	59	55	50	45	37	15		

† Capacities shown are for circulators equipped with 60 cycle motor. The 25 cycle circulator will have a lower capacity when employed against the same head.

Complete instructions and specifications: M-H Form 95-1242.

\* Larger sizes are available. Contact nearest Honeywell branch or write us direct.

† If other than standard voltage and frequency is specified, data is as follows: Motor, 1/6 H.P.; Dimensions: (A) 15-7/8"; (B) 8-1/2"; (C) 14-1/16".

# FLOW VALVES

In the V569 Flow Valves, a normally closed disc prevents any circulation of water to the radiant panel after the circulator has stopped. The flow of water induced by the circulator upon a demand for heat causes the disc to open and allow free

circulation of water through the radiant panel. An external lever permits manual opening of Flow Valve to permit gravity flow in the event the Circulator should require servicing. Flanged flow valves include companion flanges, bolts, and gaskets.



V569A FLOW VALVE

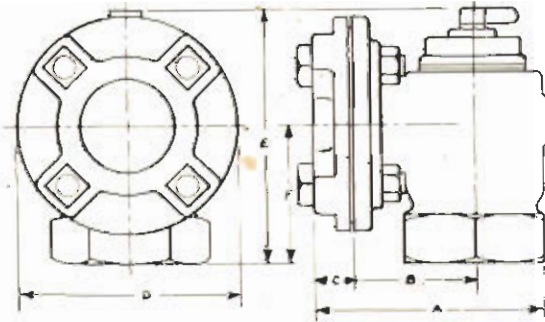

Angle Flo-Control Valve No. and Size	DIMENSIONS IN INCHES						Connections
	A	B	C	D	E	F	
V569A 1"	3-1/8	1-7/8		2-7/16	5-3/16	2-1/2	2 SCREWED CONN.
V569A 1 1/4"	3-1/8	1-7/8		2-7/16	5-3/16	2-1/2	2 SCREWED CONN.
V569A 1 1/2"	5-3/16	2-13/16	13/16	3-1/8	6	3-1/4	1 SCREWED CONN. 1-2 BOLT FLANGE
V569A 2"	5-1/4	2-13/16	7/8	4-11/16	6	3-1/4	1 SCREWED CONN. 1 FLANGED CONN.
V569A 2 1/2"	6-3/4	3-7/16	1-1/16	5-3/8	7-5/8	4-1/8	1 SCREWED CONN. 1 FLANGED CONN.
V569A 3"	7	3-5/8	1-1/8	6	7-3/4	4-1/4	1 SCREWED CONN. 1 FLANGED CONN.



V569B FLOW VALVE

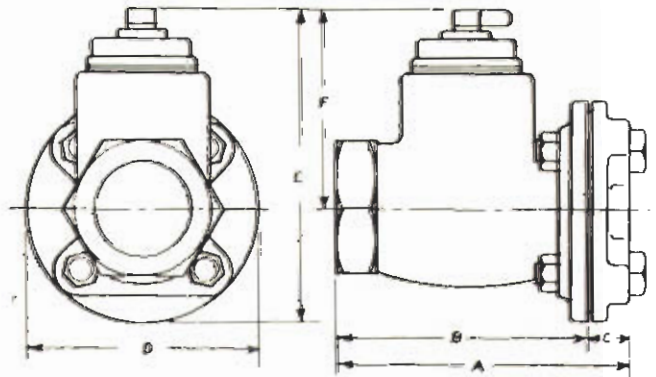

Straight Flo-Control Valve No. and Size	DIMENSIONS IN INCHES						Connections
	A	B	C	D	E	F	
V569B 1"	4-1/2			2-1/4	5-7/16	4-1/8	2 SCREWED CONN.
V569B 1 1/4"	4-1/2			2-1/4	5-7/16	4-1/8	2 SCREWED CONN.
V569B 1 1/2"	6-1/8			3-1/2	6-5/16	4-9/16	2 SCREWED CONN.
V569B 2"	6-5/8	5-3/4	7/8	4-11/16	6-3/4	4-1/2	1 SCREWED CONN. 1 FLANGED CONN.
V569B 2 1/2"	8-13/16	7-3/4	1-1/16	5-3/8	8-11/16	6	1 SCREWED CONN. 1 FLANGED CONN.
V569B 3"	9-5/16	8-3/16	1-1/8	6	9	6	1 SCREWED CONN. 1 FLANGED CONN.

FOR SHIPPING WEIGHTS AND PRICES,  
SEE PRICE LIST IN  
THE BACK OF THIS CATALOG.

## **SALES OFFICES**

### **For Minneapolis-Honeywell Regulator Co.**

Akron, Ohio	Denver, Colo.	Knoxville, Tenn.	Providence, R. I.
Albany, N. Y.	Des Moines, Iowa	Little Rock, Ark.	Richmond, Va.
Albuquerque, N. Mex.	Detroit, Mich.	Los Angeles, Calif.	Rochester, N. Y.
Amarillo, Tex.	Duluth, Minn.	Louisville, Ky.	St. Louis, Mo.
Atlanta, Ga.	East Orange, N. J.	Madison, Wisc.	Saginaw, Mich.
Baltimore, Md.	Eau Claire, Wisc.	Memphis, Tenn.	Salt Lake City, Utah
Binghamton, N. Y.	El Paso, Tex.	Menasha, Wisc.	San Antonio, Tex.
Birmingham, Ala.	Erie, Pa.	Milwaukee, Wisc.	San Francisco, Calif.
Boise, Idaho	Eugene, Ore.	Minneapolis, Minn.	Seattle, Wash.
Boston, Mass.	Fargo, N. D.	Nashville, Tenn.	Shreveport, La.
Buffalo, N. Y.	Fort Wayne, Ind.	New Haven, Conn.	Sioux City, Iowa
Charleston, W. Va.	Fresno, Calif.	New Orleans, La.	South Bend, Ind.
Charlotte, N. C.	Grand Rapids, Mich.	New York, N. Y.	Spokane, Wash.
Chicago, Ill.	Great Falls, Mont.	Oklahoma City, Okla.	Springfield, Ill.
Cincinnati, Ohio	Greenville, S. C.	Omaha, Neb.	Springfield, Mass.
Cleveland, Ohio	Harrisburg, Pa.	Peoria, Ill.	Syracuse, N. Y.
Columbus, Ohio	Hartford, Conn.	Philadelphia, Pa.	Toledo, Ohio
Corpus Christi, Tex.	Houston, Tex.	Phoenix, Ariz.	Tulsa, Okla.
Dallas, Tex.	Indianapolis, Ind.	Pittsburgh, Pa.	Washington, D. C.
Davenport, Iowa	Jacksonville, Fla.	Portland, Me.	Wichita, Kan.
Dayton, Ohio	Kansas City, Mo.	Portland, Ore.	Worcester, Mass.
			Youngstown, Ohio

### **CANADIAN OFFICES**

Calgary, Alberta • Edmonton, Alberta • Hamilton, Ontario • London, Ontario  
Montreal, Quebec • Toronto, Ontario • Vancouver, B. C. • Winnipeg, Manitoba

### **FOREIGN OFFICES**

Amsterdam, Holland • Brussels, Belgium • London, England • Mexico City, Mexico  
Stockholm, Sweden • Zurich, Switzerland • Monterrey N.L., Mexico  
Guadalajara, Jalisco, Mexico • Santurce, Puerto Rico

### **General Offices & Main Plant**

## **MINNEAPOLIS-HONEYWELL REGULATOR CO.**

2753 FOURTH AVENUE SOUTH, MINNEAPOLIS 8, MINNESOTA  
LEASIDE, TORONTO 17, CANADA